

SHARP®

ELECTRONIC CASH REGISTER

MODEL
XE-A307

FULL DETAILED INSTRUCTION MANUAL



CAUTION:

The cash register is should be securely fitted to the supporting platform to avoid instability when the drawer is open.

CAUTION:

The socket-outlet shall be installed near the equipment and shall be easily accessible.

VORSICHT:

Die Netzsteckdose muß nahe dem Gerät angebracht und leicht zugänglich sein.

ATTENTION:

La prise de courant murale devra être installée à proximité de l'équipement et devra être facilement accessible.

AVISO:

El tomacorriente debe estar instalado cerca del equipo y debe quedar bien accesible.

VARNING:

Det matande vägguttaget skall placeras nära apparaten och vara lätt åtkomligt.

LET OP:

Het stopcontact dient in de buurt van de kassa en gemakkelijk toegankelijk te zijn.

CAUTION:

For a complete electrical disconnection pull out the mains plug.

VORSICHT:

Zur vollständigen elektrischen Trennung vom Netz den Netzstecker ziehen.

ATTENTION:

Pour obtenir une mise hors-circuit totale, débrancher la prise de courant secteur.

AVISO:

Para una desconexión eléctrica completa, desenchufar el enchufe de tomacorriente.

VARNING:

För att helt koppla från strömmen, dra ut stickproppen.

LET OP:

Trek de stekker uit het stopcontact indien u de stroom geheel wilt uitschakelen.

Authorized representative responsible for the European Union Community Market
Autorisierter Repräsentant in der Europäischen Union
Représentant autorisé pour le marché de la communauté européenne
Representante autorizado responsable para el Mercado Común de la Unión Europea
Auktoriserad representant ansvarig för EU marknaden
Geautoriseerde vertegenwoordiger in de Europese Unie

SHARP ELECTRONICS (Europe) GmbH
Sonninstraße 3, D-20097 Hamburg

INTRODUCTION

Thank you very much for your purchase of the SHARP Electronic Cash Register, Model XE-A307.

Please read this manual carefully before operating your machine in order to gain full understanding of functions and features.

Please keep this manual for future reference. It will help you if you encounter any operational problems.

IMPORTANT

- Be very careful when removing and replacing the printer cover, as the cutter mounted on it is very sharp.
- Install the cash register in a location not subject to direct sunlight, unusual temperature changes, high humidity or splashing water.
Installation in such locations could cause damage to the cabinet and the electronic components.
- Never install the register in saline areas (e.g.: close to the sea).
Installing the register in such locations could cause component failure with the corrosion.
- Never operate the register with wet hands.
The water could seep into the interior of the register and cause component failure.
- When cleaning your register, use a dry, soft cloth. Never use solvents, such as benzine and/or thinner.
The use of such chemicals will lead to discoloration or deterioration of the cabinet.
- The register plugs into any standard wall outlet (official (nominal) voltage).
Other electrical devices on the same electrical circuit could cause the register to malfunction.
- For protection against data loss, please install two alkaline batteries LR6 ("AA" size) after initializing the register. When handling the batteries, please observe the following:
Incorrectly using batteries can cause them to burst or leak, possibly damaging the interior of the register.
 - RISK OF EXPLOSION IF BATTERY IS REPLACED BY AN INCORRECT TYPE.
DISPOSE OF USED BATTERIES ACCORDING TO THE INSTRUCTIONS.
 - Be sure that the positive (+) and negative (-) poles of each battery are facing in the proper direction for installation.
 - Never mix batteries of different types.
 - Never mix old batteries and new ones.
 - Never leave dead batteries in the battery compartment.
 - Remove the batteries if you do not plan to use the register for long periods.
 - Should a battery leak, clean out the battery compartment immediately, taking care to avoid letting the battery fluid come into direct contact with your skin.
 - For battery disposal, follow the corresponding law in your country.
- For complete electrical disconnection, disconnect the main plug.

Caution Scanner connection

In order to allow a plug & play connection of the optional scanner the Pin 9 of the D-Sub connector uses +5V.

Be very careful of this +5V in case connection of a different device should be done so that a damage of the register or device is avoided.

CONTENTS

INTRODUCTION	3
IMPORTANT	3
CONTENTS	4
1 Part Names and Functions	8
External View	8
Front view	8
Rear view	8
Printer	9
Keyboard	10
Keyboard layout	10
Function key list	10
RS232 Connector/SD Card Slot	11
RS232 connector	11
SD card slot	11
Displays	12
Operator display	12
Customer display	13
Screen save mode	13
2 Selecting an Operating Mode	14
Operating Modes	14
Mode Selection	15
3 Prior to Making Entries	16
Preparations for Entries	16
Receipt paper roll	16
Receipt ON/OFF function	16
Clerk assignment	16
Error Warning	16
Item Selection from the Menu	17
Starting Cash Memory Entry	17
HELP FUNCTION	18
Printing the help menu	18
Printing guidance messages	18
4 Entries	19
Item Entries	19
Single item entries	19
Repeat entries	21
Multiplication entries	22
Split-pricing entries	23
Single item cash sale (SICS)	24
EAN learning function (creation and registration of unknown EANs)	25
Display of Subtotals	26
Subtotal	26
Finalization of Transaction	27
Cash or check tendering	27
Mixed tendering (check + cash)	28
Cash or check sale that does not need any tender entry	28
Credit sale	29
Mixed-tender sale (cash or check tendering + credit tendering)	29
Computation of VAT (Value Added Tax)/Tax	30
VAT/tax system	30
Auxiliary Entries	32

Percent calculations (premium or discount)	32
Discount entries	33
Refund entries	33
Printing of non-add code numbers	34
Payment Treatment	34
Currency exchange	34
Received-on-account entries	35
Paid-out entries	35
No-sale (exchange)	36
Cashing a check	36
Electronic Journal View	36
TRAINING Mode.....	37
Overlapped Clerk Entry	38
5 Correction	39
Correction of the Last Entry (Direct Void)	39
Correction of the Next-to-Last or Earlier Entries (Indirect Void).....	40
Subtotal Void.....	41
Correction after Finalizing a Transaction	41
6 Special Printing Function	42
Copy Receipt Printing.....	42
Guest Check Receipt (Bill Print)	43
7 Manager Mode	44
Entering the Manager Mode	44
Override Entries.....	44
8 Reading (X) and Resetting (Z) of Sales Totals	45
How to take a X1/Z1 or X2/Z2 report.....	45
Flash report	45
Daily Sales Totals	48
General report	48
Department report	51
Individual group total report on departments	52
Full group total report on departments	52
Transaction report	53
Total in drawer report	53
PLU/EAN report by designated range	54
PLU/EAN report by associated department.....	55
PLU/EAN zero sales report (full)	55
PLU/EAN zero sales report (by dept.)	55
Individual clerk report	56
All clerk report	56
Hourly report.....	57
Periodic Report Sample.....	58
General information	58
Daily net report	59
Compulsory Cash/Check Declaration.....	60
Display sample	61
Report sample	61
9 Non-accessed EAN Deletion	62
Non-accessed EAN report.....	62
10 Prior to Programming	63
Programming Keyboard Layout.....	63
How to Program Alphanumeric Characters	65
Mobile phone method	65

Entering character codes.....	66
11 Programming	67
Basic Instructions.....	67
Programming screen	67
Programming example	68
Article Programming	70
Department.....	71
PLU/EAN	72
PLU range	73
EAN Non-PLU code format	74
EAN delete	75
Functional Programming.....	76
Discount (⊖).....	77
Percent (%1 , %2)	78
RA.....	78
PO	79
CID (Cash in drawer).....	79
CHK/CG (Check change)	79
Check cashing	80
Media Key Programming	81
Cash key (Cash).....	82
Check key (Check1, Check2)	82
Credit key (Credit1, Credit2).....	83
Foreign currency (Exchange1, Exchange2)	84
Function Text Programming.....	85
Personnel Programming	87
Clerk	87
Manager	88
Mode Pass Code	88
Training Clerk	89
Terminal Programming.....	90
Date/Time Setting	91
Date/time	91
Optional Feature Selection	92
Basic System	93
Rounding	94
Function Prohibit.....	95
Function Authority	96
Function Selection	97
Print Selection	98
EAN Function	99
Exchange Function.....	100
EURO Change.....	101
Report Programming	102
Zero skip.....	103
Print select.....	103
Z Counter.....	104
Z1 General report	105
Hourly report.....	105
Journal data.....	105
CCD Function	106
Message Programming.....	107
Receipt logo.....	107

Device Configuration Programming.....	108
Keyboard	109
Display.....	109
Printer	109
RS Port.....	109
Online	110
Scanner	110
Tax Programming.....	111
Tax system.....	111
Tax 1 through 4.....	111
Automatic Sequencing Key Programming.....	112
Key Text.....	112
Key Sequence	113
Reading of Stored Programs	114
Program reading sequence	114
Sample printouts.....	115
SD CARD Mode.....	123
Inserting and removing an SD memory card	123
SD card formatting.....	123
Folder creating.....	123
Folder name selecting	123
Data saving	124
Data loading	125
12 Electronic Journal	126
Electronic journal	126
13 European Article Number (EAN) or Universal Product Code (UPC)	127
EAN or UPC code.....	127
Add-on code	129
14 EURO Migration Function	130
15 Operator Maintenance	132
In Case of Power Failure	132
In Case of Printer Error.....	132
Cautions in Handling the Printer and Recording Paper.....	132
Cautions in handling the printer.....	132
Cautions in handling the recording paper (thermal paper)	132
Installing Batteries	133
Replacing the Paper Roll.....	135
Recording paper specifications	135
Installing Paper Rolls.....	135
Replacing the paper roll.....	138
Removing a Paper Jam	138
Cleaning the Printer (Printer Head/Sensor/Roller).....	139
Removing the Till and the Drawer.....	140
Opening the Drawer by Hand	140
Drawer Lock Key	140
Installing the Fixing Angle Bracket.....	141
Before Calling for Service.....	142
16 Specifications	143

1 Part Names and Functions

External View

■ Front view

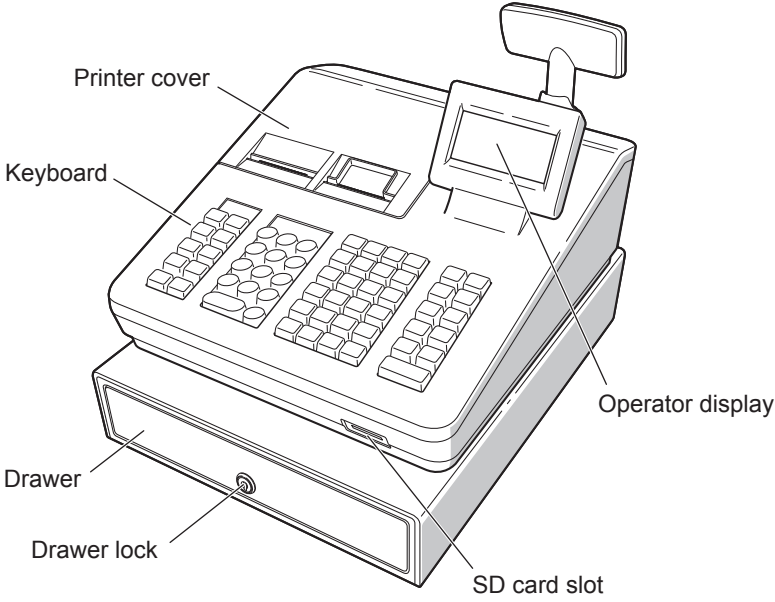

■ Rear view

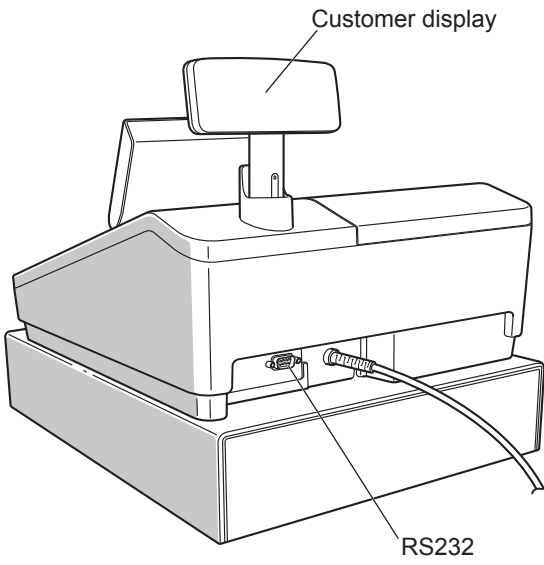

Printer

The printer is a receipt/journal dual station type thermal printer, and therefore it does not require any type of ink ribbon or cartridge. The average life of the printer is approximately 5 million lines.

When removing the printer cover, lift up its rear.

When installing the printer cover, hook it on the pawls on the cabinet and shut it.

CAUTION: The paper cutter is mounted on the printer cover. Be careful not to cut yourself.

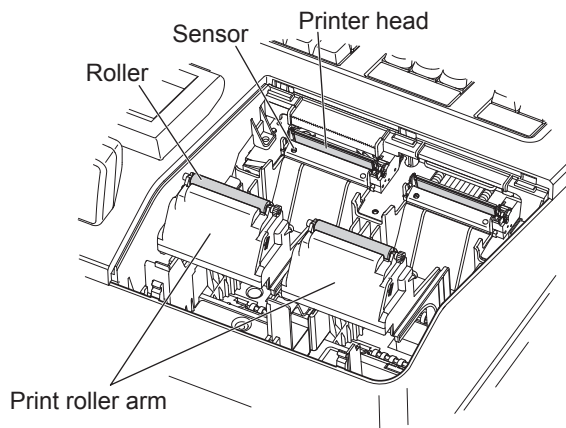
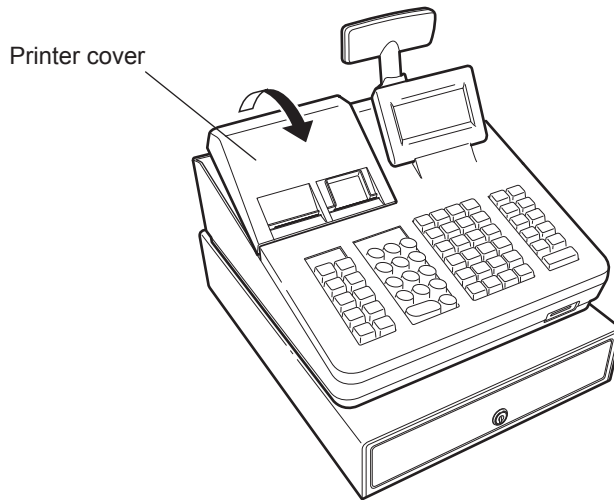

NOTE Do not attempt to remove the paper with the print roller arm in the hold position. This may result in damage to the printer and printer head.

Keyboard

Keyboard layout

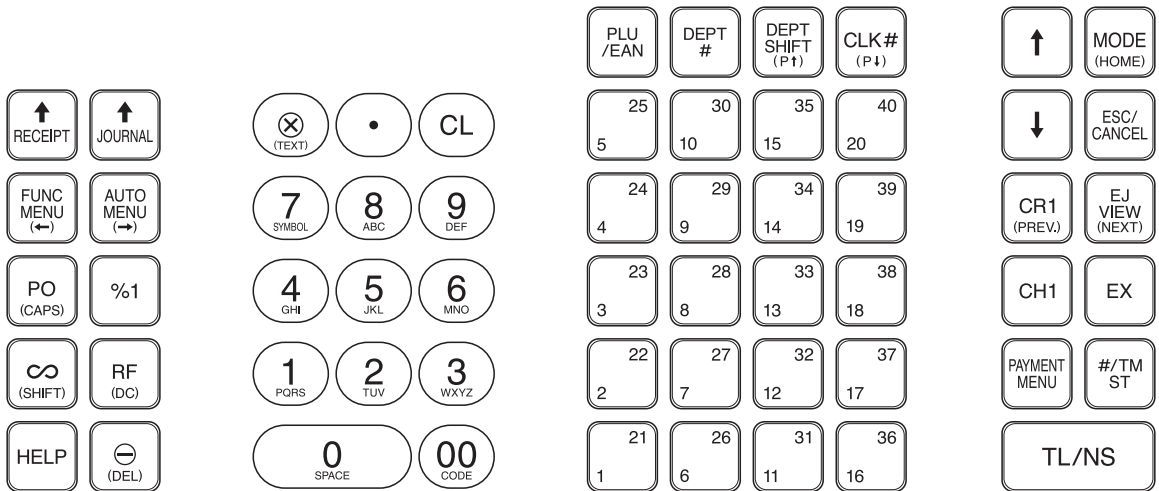

Function key list

	Receipt paper feed key		Price lookup/EAN key
	Journal paper feed key		Department code entry key
	Function menu key		Department shift key
	Auto menu key		Clerk code entry key
	Paid out key		Department 1-40 key
	Percent 1 key		Cursor (up/down arrow) key
	Void key		Mode key
	Refund key		Escape/Cancel key
	Help key		Credit 1 key
	Discount key		Electronic journal view key
	Multiplication key		Foreign currency exchange key
	Decimal point key		Check 1 key
	Clear key		Payment menu key
	Numeric key		Non-add code/Time display/Subtotal key
			Total/No sale key

RS232 Connector/SD Card Slot

■ RS232 connector

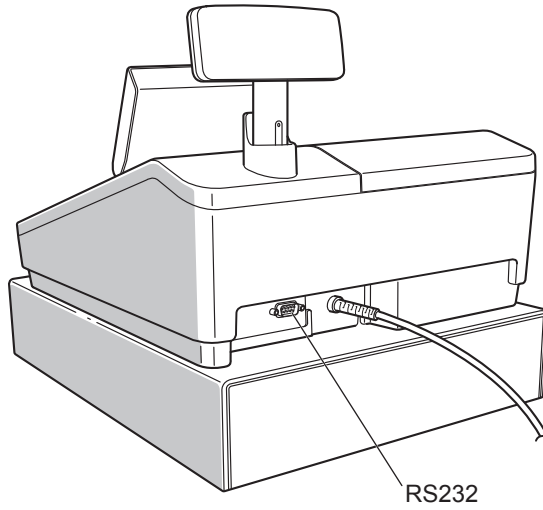

■ SD card slot

Refer to the “SD CARD Mode” section.

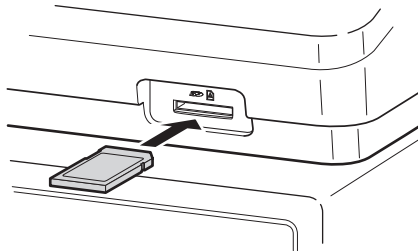

Displays

■ Operator display

• Screen example 1 (REG mode)

```

1x125.20      125.20
PLU00001
***TOTAL      125.20
PLU00001      125.20
REG           R  01
    
```

Labels below the screen:

- Mode name (points to PLU00001)
- Status information (points to R)
- Clerk code (points to 01)

Sales information area:

When a transaction information occupies more than 2 lines, you can scroll to the direction by using the keys. Sales information you have just entered such as items and prices will appear between 1st line and 2nd line. Total is always appear at 3rd line.

Numeric Entry Area:

Status area:

Receipt ON/OFF status indicator (R) : Appears when the receipt ON-OFF function signs OFF.

Electronic journal near full indicator (□) : Appears (□) when the used memory is 80%.

: Appears (▣) when the used memory is 90%.

: Appears (■) when the used memory is 95%.

Sentinel mark (X) :

Appears when the cash in drawer exceeds a programmed sentinel amount. The sentinel check is performed for the total cash in drawer.

• Screen example 2 (PGM mode)

```

00001
PRICE      125.20
          PLU00001
TYPE      PRESET
DEPT.CODE 01
NON-ACCESS NON DEL.
PGM              01
    
```

Labels below the screen:

- Mode name (points to 00001)
- Clerk code (points to 01)

Programming area: Programmable items are listed.

Status area:

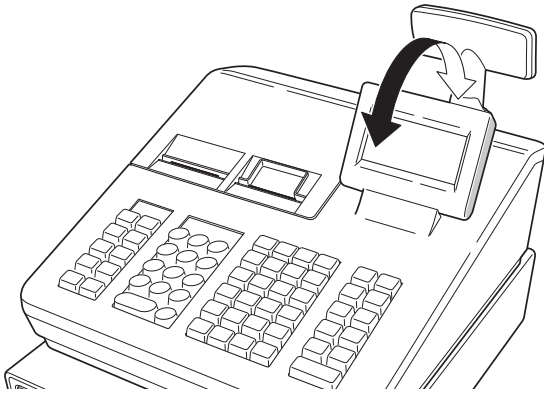

The display can be tilted back and forth to the best operational viewing angle.

NOTE

Do not try to force the display beyond its full position.

■ **Customer display**



■ **Screen save mode**

When you want to save the electric power or save the display's life, use the screen save function. This function can turn off the display and the LCD backlight when any clerk does not operate the register for an extended period of time. You can program the time for which your register should keep the normal status (in which the backlight is "ON") before it goes into the screen save mode.

This machine will enter the screen save mode two minutes later by default.

To go back to the normal mode, press any key.

The backlight in display is a consumable part.

When the LCD display may no longer be adjusted and become darker, you should replace the LCD unit.

Consult your authorized SHARP dealer for further details.

2

Selecting an Operating Mode

When you turn the register on and press the **MODE** key, the mode selection window will appear on the display, listing available operating modes as shown below.

Mode selection window

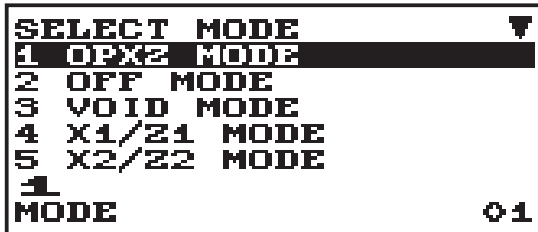

Operating Modes

You can select any mode other than REG from the list in the mode selection window. Your register supports the following operating modes:

REG mode	This mode allows you to enter various sales information. The mode selection window does not list this mode. To select this mode from the mode selection window, press the ESC/CANCEL key.
OPXZ mode	This mode allows clerks to take X or Z reports on their sales information.
OFF mode	This mode locks all operations of the register. When you select this mode, the window will disappear. Pressing any key turns the register ON.
VOID mode:	This mode allows correction after finalizing a transaction.
X1/Z1 mode	This mode is used to take various daily total reports (X1/Z1 reports).
X2/Z2 mode	This mode is used to take various weekly or monthly reports (X2/Z2 reports).
PGM mode	This mode is used to program various items.
SD CARD mode	This mode allows you to save and load the data of your register to and from an SD card.

Mode Selection

Procedure

Press the **MODE** key. The following mode screen is displayed.

```
SELECT MODE
1 OPX2 MODE
2 OFF MODE
3 VOID MODE
4 X1/Z1 MODE
5 X2/Z2 MODE
1
MODE O1
```

Use one of the following ways:

- Move the cursor to the desired option by using the **↑** or **↓** key, and press the **TL/NS** key.
- Enter the desired option number by using a numeric key and press the **TL/NS** key.

NOTE When you want to enter the REG mode, simply press the **ESC/CANCEL** key.

3

Prior to Making Entries

Preparations for Entries

■ Receipt paper roll

If the receipt paper roll is not set in the machine or it is getting low, install a new one according to section “Replacing the Paper Roll” under “Operator Maintenance.”

■ Receipt ON/OFF function

You can disable receipt printing in the REG mode to save paper using the receipt function. Press the **FUNC MENU** key. Select “4 RECEIPT SW” and press the **TL/NS** key. Select “OFF” to disable receipt printing and press the **TL/NS** key. When the function is in the OFF status, the receipt off indicator “R” is highlighted.

NOTE Your register will print reports regardless of the receipt state. This means that the receipt roll must be installed even when the receipt state is “OFF”.

■ Clerk assignment

Prior to any item entries, a clerk must enter his/her clerk codes into the register.

To sign on:

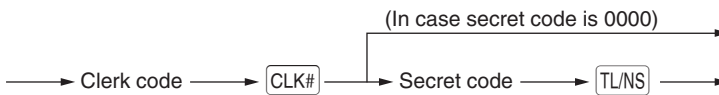

To sign off:



Error Warning

In the following examples, your register will go into an error state accompanied with a warning beep and the error message on the display. Clear the error state by pressing the **CL** key and then take the proper action to remedy the problem.

- When you exceed a 32-digit number (entry limit overflow):
Cancel the entry and reenter a correct number.
- When you make an error in key operation:
Clear the error and try the entry again.
- When you make an entry beyond a programmed amount entry limit:
Check to see if the entered amount is correct. If it is correct, it can be rung up in the MGR mode.
Contact your manager.
- When an including-tax subtotal exceeds eight digits:
Clear the error message by pressing the **CL** key and then press a media key to finalize the transaction.

Error escape function

To quit a transaction due to an error or an unforeseen event, use the error escape function as shown below:

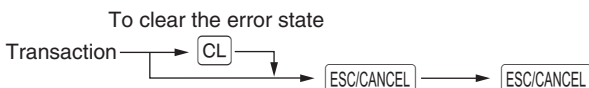

The transaction is voided (treated as a subtotal void) and the receipt is issued by this function. If you have already entered a tendered amount, the operation is finalized as a cash sale.

Item Selection from the Menu

Your register allows you to select functions from a menu. There are three menus available from the key selection on the keyboard; **FUNC MENU**, **PAYMENT MENU** and **AUTO MENU**. Each menu can be opened as follows:

• AUTO MENU

```

AUTO MENU
1 AUTO 1
2 AUTO 2
3 AUTO 3
4 AUTO 4
5 AUTO 5
REG 01
    
```

• FUNCTION MENU

```

FUNCTION MENU ▼
1 G.C.RCPT
2 ***RA
3 2
***TOTAL 0.00
REG 01
    
```

• PAYMENT MENU

```

PAYMENT MENU
1 CHECK2
2 CREDIT2
3 VAT
***TOTAL 0.00
REG 01
    
```

```

FUNCTION MENU ▲
3 2
4 RECEIPT SW
5 RCPT
***TOTAL 0.00
REG 01
    
```

Procedure

In the REG mode, press **FUNC MENU** key, **PAYMENT MENU** key or **AUTO MENU** key. The corresponding menu list appears.

Starting Cash Memory Entry

If you enter the amount of currency for the starting amount in the drawer before entry operations, you can separate that amount from the sales amount when reports are generated.

Your register can be programmed to enforce the entry of starting cash into memory.

Procedure

1. Press the **MODE** key.
2. Select the "1 OPXZ MODE" and press the **TL/NS** key.
3. Select the desired option "3 SCM(+)" or "4 SCM(-)" by using the **↓** key and press the **TL/NS** key.

```

SCM(+)
AMOUNT 0.00
  

OPXZ 01
    
```

Enter the amount for domestic currency by using the **TL/NS** key.

```

CLK#01 CLERK01
  

SCM(+) #0.00
SCM TTL *100.00
*100.00
    
```

HELP FUNCTION

The help function allows you to print guidance messages for basic programming procedures of the cash register.

■ Printing the help menu

Press the **[HELP]** key to print the help menu. This menu provides a list of the programming procedures for which you can print the guidance messages.

Example	Key operation	Print
	[HELP]	<pre>HELP MENU 1 HOW TO SET THE PAPER 2 EJ VIEW 3 DATE SETTING 4 TIME SETTING 5 VAT RATE SETTING 6 VAT TEXT SETTING 7 VAT ASSIGNMENT TO DEPT. 8 DEPARTMENT TEXT SETTING 9 MINUS DEPARTMENT SETTING 10 PLU TO DEPT. ASSIGNMENT 11 PLU TEXT SETTING 12 PLU PRICE SETTING 13 LOGO MESSAGE SETTING 14 REPORT PRINT 15 HOW TO SIGN ON A CLERK 16 HOW TO SET RCPT SW OFF/ON 17 HOW TO FORMAT SD CARD TO PRINT ABOVE EACH HELP CONTENTS, EX) 1 [HELP].</pre>

■ Printing guidance messages

By reference to the help menu above, press the corresponding numeric key and then the **[HELP]** key to print the guidance message for each programming procedure.

Example	Key operation	Print
	4 [HELP]	<pre>4 TIME SETTING Mode selection: PGM MODE Select "2 SETTING". Select "7 DATE/TIME". Push [↓] key to skip DATE. EX) PM 4:30 (TIME FORMAT=24 HOUR) 1630 [TL/NS]</pre>

Sample print of TIME SETTING

4 Entries

Item Entries

Single item entries

Department entries (direct department entries)

Enter a unit price and press a department key. If you use a programmed unit price, press a department key only.

Procedure

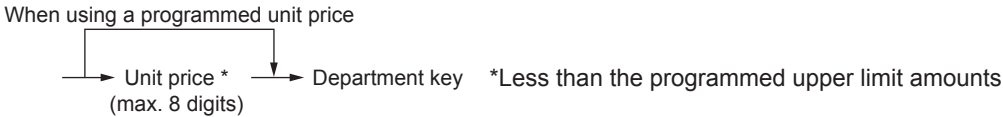

- NOTE**
- When using the department key 21 to 40, you need to press the **DEPT SHIFT** key before pressing the department key.
 - When those departments for which the unit price has been programmed as zero (0) are entered, only the sales quantity is added.

Department entries (indirect department entries)

The register provides a maximum of 99 departments for a merchandise classification. Group attributes, such as taxable status, are applied to items when they are entered to the departments.

Procedure

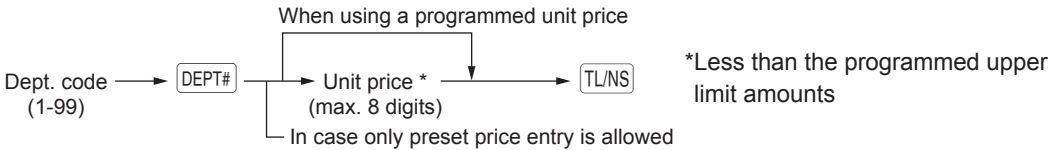

- NOTE**
- You can directly enter the code No. of the department using the numeric key. For the code No. exceeding the figure on the numerical key board (41 and above), use this function.

Example

Key operation	Print
1200 <input type="button" value="6"/>	1x 12.00 *12.00
<input type="button" value="5"/>	DPT. 06
3 <input type="button" value="DEPT#"/>	1x 7.10 *7.10
520	DPT. 05
<input type="button" value="TL/NS"/>	1x 5.20 *5.20
<input type="button" value="4"/>	DPT. 03
<input type="button" value="TL/NS"/>	1x 6.80 *6.80
	DPT. 04
	CASH *31.10

PLU entries

Enter a PLU code and press the key. If you not use a programmed unit price, you need to enter a unit price after pressing the key.

Procedure

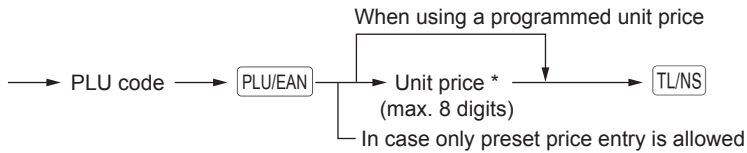

NOTE When those PLUs for which the unit price has been programmed as zero (0) are entered, only the sales quantity is added.

Example

Key operation	Print
2 <input type="button" value="PLU/EAN"/>	1x 5.10 *5.10
16 <input type="button" value="PLU/EAN"/>	PLU00002
1200	1x 12.00 *12.00
<input type="button" value="TL/NS"/>	PLU00016
<input type="button" value="TL/NS"/>	CASH *17.10

EAN entries

Procedure

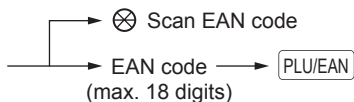

* After an EAN entry, you may be requested to enter a unit price with the display “UNDEFINED CODE” and beep sound. In this case, enter the unit price and press the **TL/NS** key, enter the department code and press the **TL/NS** key, and select the delete type with the **TL/NS** key (EAN learning function).

Example

Key operation	Print						
5012345678900 PLU/EAN TL/NS	<table border="1"> <tr> <td style="text-align: left;">1x 3.10</td> <td style="text-align: right;">*3.10</td> </tr> <tr> <td colspan="2" style="text-align: left;">5012345678900# Item-A</td> </tr> <tr> <td style="text-align: left;">CASH</td> <td style="text-align: right;">*3.10</td> </tr> </table>	1x 3.10	*3.10	5012345678900# Item-A		CASH	*3.10
1x 3.10	*3.10						
5012345678900# Item-A							
CASH	*3.10						

Repeat entries

You can use this function for entering a sale of two or more the same items.

You can simply press the department key, **DEPT#**, or **PLU/EAN** key to repeat entry.

Example

	Key operation	Print																						
Repeated department entry (direct)	200 2 2 2 4	<table border="1"> <tr> <td style="text-align: left;">3x 2.00</td> <td style="text-align: right;">*6.00</td> </tr> <tr> <td colspan="2" style="text-align: left;">DPT. 02</td> </tr> <tr> <td style="text-align: left;">2x 6.80</td> <td style="text-align: right;">*13.60</td> </tr> <tr> <td colspan="2" style="text-align: left;">DPT. 04</td> </tr> <tr> <td style="text-align: left;">3x 5.10</td> <td style="text-align: right;">*15.30</td> </tr> <tr> <td colspan="2" style="text-align: left;">PLU00010</td> </tr> <tr> <td style="text-align: left;">2x 3.10</td> <td style="text-align: right;">*6.20</td> </tr> <tr> <td colspan="2" style="text-align: left;">5012345678900# Item-A</td> </tr> <tr> <td style="text-align: left;">2x 5.00</td> <td style="text-align: right;">*10.00</td> </tr> <tr> <td colspan="2" style="text-align: left;">PLU00060</td> </tr> <tr> <td style="text-align: left;">CASH</td> <td style="text-align: right;">*51.10</td> </tr> </table>	3x 2.00	*6.00	DPT. 02		2x 6.80	*13.60	DPT. 04		3x 5.10	*15.30	PLU00010		2x 3.10	*6.20	5012345678900# Item-A		2x 5.00	*10.00	PLU00060		CASH	*51.10
3x 2.00	*6.00																							
DPT. 02																								
2x 6.80	*13.60																							
DPT. 04																								
3x 5.10	*15.30																							
PLU00010																								
2x 3.10	*6.20																							
5012345678900# Item-A																								
2x 5.00	*10.00																							
PLU00060																								
CASH	*51.10																							
Repeated department entry (indirect)	DEPT# 680 TL/NS DEPT#																							
Repeated PLU entry	10 PLU/EAN PLU/EAN PLU/EAN																							
Repeated EAN entry	5012345678900 PLU/EAN PLU/EAN																							
Repeated subdepartment entry	60 PLU/EAN 500 TL/NS PLU/EAN TL/NS																							

■ Multiplication entries

Use this feature when you need to enter two or more the same items.

This feature helps you when you sell a large quantity of items or need to enter quantities that contain decimals.

Procedure

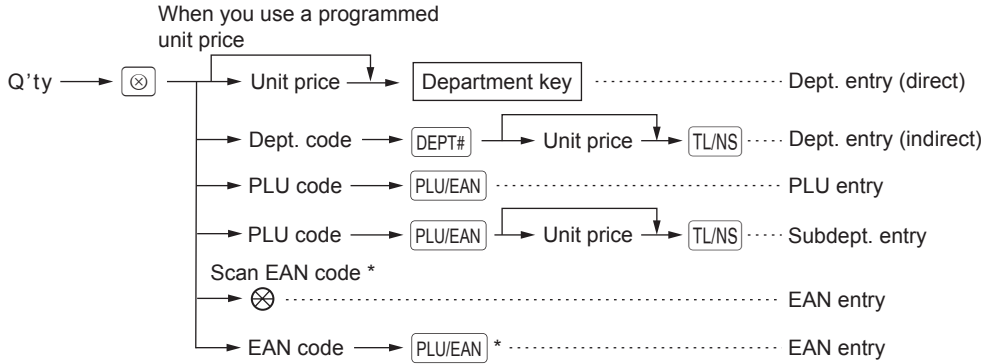

* After an EAN entry, you may be requested to enter a unit price with the display “UNDEFINED CODE” and beep sound. In this case, enter the unit price and press the **TL/NS** key, enter the department code and press the **TL/NS** key, and select the delete type with the **TL/NS** key (EAN learning function).

- Q'ty: Up to four-digit integer + three-digit decimal
- Unit price: Less than a programmed upper limit
- Q'ty x unit price: Up to eight digits

Example

Key operation	Print
7 . 5 ⊗	7.500x 1.65 *12.38
165 2 ⊗	DPT. 02 2x 2.50 *5.00
2 ⊗	DPT. 05
5 DEPT#	15x 2.10 *31.50
250	PLU00008
TL/NS	8x 3.10 *24.80
15 ⊗	5012345678900#
8 PLU/EAN	Item-A
8 ⊗	3x 1.00 *3.00
5012345678900 PLU/EAN	PLU00060
3 ⊗	CASH *76.68
60 PLU/EAN	
100	
TL/NS	
TL/NS	

■ Split-pricing entries

You will use this function when your customer wants to purchase more or less than the base quantity of a loose item.

Procedure

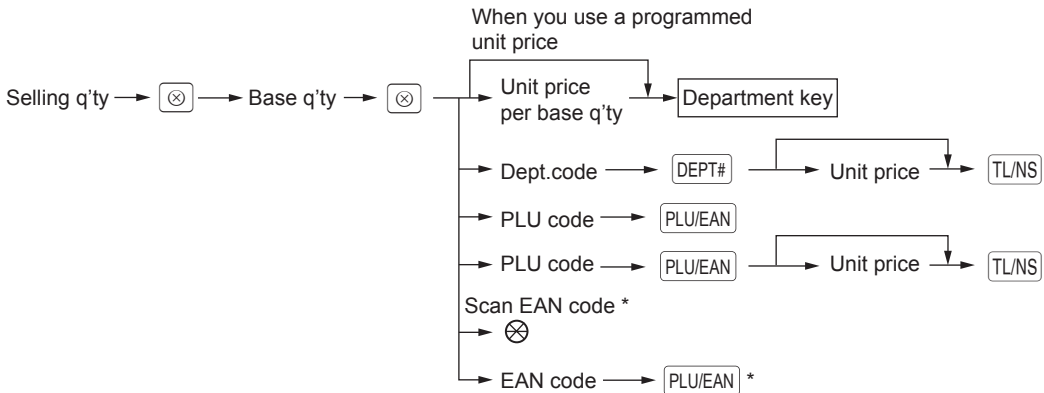

* After an EAN entry, you may be requested to enter a unit price with the display “UNDEFINED CODE” and beep sound. In this case, enter the unit price and press the **TL/NS** key, enter the department code and press the **TL/NS** key, and select the delete type with the **TL/NS** key (EAN learning function).

- Selling quantity: Up to four-digit integer + three-digit decimal
- Base quantity: Up to two digits (integer)

Example

Key operation	Print
7 ⊗ 10 ⊗	7x 10/ 6.00 *4.20
600 2	DPT.02
8 ⊗ 5 ⊗	8x 5/ 1.50 *2.40
35 PLU/EAN	PLU00035
5 ⊗ 6 ⊗	5x 6/ 3.60 *3.00
5045678912304 PLU/EAN	5045678912304#
TL/NS	Item-C
	CASH *9.60

■ Single item cash sale (SICS)

- This function is useful when a sale is for only one item and is for cash; such as a pack of cigarettes. This function is applicable only to those departments that have been set for SICS or to their associated PLUs, subdepartments or EANs.
- The transaction is finalized and the drawer opens as soon as you press the department key, **DEPT#** key or **PLU/EAN** key.

Example

Key operation	Print						
For finishing the transaction → 3	<table border="1"> <tr> <td>1x 2.50</td> <td>*2.50</td> </tr> <tr> <td>DPT. 03</td> <td></td> </tr> <tr> <td>CASH</td> <td>*2.50</td> </tr> </table>	1x 2.50	*2.50	DPT. 03		CASH	*2.50
1x 2.50	*2.50						
DPT. 03							
CASH	*2.50						

NOTE

If an entry to a department, PLU/subdepartment or EAN set for SICS follows the ones to departments, PLUs/subdepartments or EANs not set for SICS, it does not finalize and results in a normal sale.

■ EAN learning function (creation and registration of unknown EANs)

When you enter or scan an undefined EAN code, you are required to enter its unit price and the associated department. The code, associated department and unit price entered are stored in the EAN file and used for future EAN sales entries.

NOTE

- When there is no capacity remained in the file, the data is not stored in the file.
- For the text for the EAN code, the text of its associated department is applied.
- You can use the EAN learning function in the training mode. This may be convenient to build up the programming data of EANs by the scanning system.

Procedure

"UNDEFINED CODE" is displayed with beep sounds and price input window is displayed.

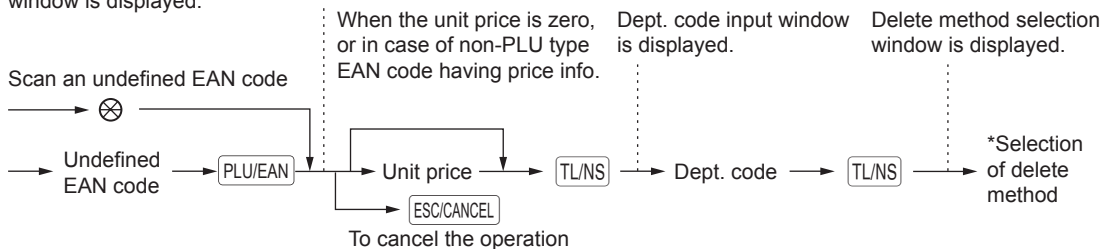

* Select "1 AUTO DELETE" when you want to exempt the EAN code entered from the non-accessed EAN delete function (deletion by selecting DELETE option from EAN DELETE menu in X1/Z1 mode). When the "2 NO DELETE" is selected, the item is not deleted by the non-accessed EAN deletion.

NOTE

For the repeat entry, use the **PLU/EAN** key.

Example

Key operation	Print
5099887654302 PLU/EAN	
"UNDEFINED CODE" is displayed. → 750 TL/NS	1x 7.50 *7.50
5 TL/NS	5099887654302#
Select "1 AUTO DELETE". → 1 TL/NS	DPT. 05
	CASH *7.50

Display of Subtotals

Your register provides the following types of subtotals:

■ Subtotal

Press the #/TM/ST key at any point during a transaction. The sales subtotal including tax will appear in the display.

Finalization of Transaction

■ Cash or check tendering

Press the **#/TM/ST** key to get an including-tax subtotal, enter the amount tendered by your customer, then press the **TL/NS** key if it is a cash tender or press the **CH1** key if it is a check tender. When the amount tendered is greater than the amount of the sale, your register will show the change due amount and the symbol “CHANGE.” Otherwise your register will show the symbol “DUE” and a deficit. Make a correct tender entry.

Example

Cash tendering

Key operation	Print														
} #/TM/ST 1000 TL/NS	<table border="1"> <tr> <td>1x 1.20</td> <td style="text-align: right;">*1.20</td> </tr> <tr> <td>PLU00001</td> <td></td> </tr> <tr> <td>1x 2.50</td> <td style="text-align: right;">*2.50</td> </tr> <tr> <td>PLU00002</td> <td></td> </tr> <tr> <td>***TOTAL</td> <td style="text-align: right;">*3.70</td> </tr> <tr> <td>CASH</td> <td style="text-align: right;">*10.00</td> </tr> <tr> <td>CHANGE</td> <td style="text-align: right;">*6.30</td> </tr> </table>	1x 1.20	*1.20	PLU00001		1x 2.50	*2.50	PLU00002		***TOTAL	*3.70	CASH	*10.00	CHANGE	*6.30
1x 1.20	*1.20														
PLU00001															
1x 2.50	*2.50														
PLU00002															
***TOTAL	*3.70														
CASH	*10.00														
CHANGE	*6.30														

Check tendering

Key operation	Print														
} #/TM/ST 1000 CH1	<table border="1"> <tr> <td>1x 1.20</td> <td style="text-align: right;">*1.20</td> </tr> <tr> <td>PLU00001</td> <td></td> </tr> <tr> <td>1x 2.50</td> <td style="text-align: right;">*2.50</td> </tr> <tr> <td>PLU00002</td> <td></td> </tr> <tr> <td>***TOTAL</td> <td style="text-align: right;">*3.70</td> </tr> <tr> <td>CHECK1</td> <td style="text-align: right;">*10.00</td> </tr> <tr> <td>CHANGE</td> <td style="text-align: right;">*6.30</td> </tr> </table>	1x 1.20	*1.20	PLU00001		1x 2.50	*2.50	PLU00002		***TOTAL	*3.70	CHECK1	*10.00	CHANGE	*6.30
1x 1.20	*1.20														
PLU00001															
1x 2.50	*2.50														
PLU00002															
***TOTAL	*3.70														
CHECK1	*10.00														
CHANGE	*6.30														

NOTE You can also enter a check tender from the **PAYMENT** menu window. Press the **PAYMENT MENU** key and select “1 CHECK 2” and enter the amount.

■ Mixed tendering (check + cash)

Example

Key operation

}
 #/TM/ST
 1000 CH1
 500 TL/NS

Print

1x 5.10	*5.10
PLU00010	
2x 4.80	*9.60
PLU00008	
***TOTAL	*14.70
CHECK1	*10.00
CASH	*5.00
CHANGE	*0.30

■ Cash or check sale that does not need any tender entry

Enter items and press the **TL/NS** key if it is a cash sale or press the **CH1** key if it is a check sale. Your register will display the total sales amount.

Example

Key operation

6 PLU/EAN
 10 PLU/EAN
 TL/NS

Print

1x 3.00	*3.00
PLU00006	
1x 7.15	*7.15
PLU00010	
CASH	*10.15

In the case of check sale

1x 3.00	*3.00
PLU00006	
1x 7.15	*7.15
PLU00010	
CHECK1	*10.15

■ Credit sale

Enter items and press the **CR1** key.

Example	Key operation	Print
	6 PLU/EAN	
	7 PLU/EAN	1x 3.00 *3.00
	#/TM/ST	PLU00006
	CR1	1x 6.00 *6.00
		PLU00007
		CREDIT1 *9.00

NOTE

- Amount tendering operations (i.e. change calculations) can be achieved by the **CR1** key when a PGM mode programming allows them.
- You can also enter a credit tender from the PAYMENT menu window. Press the **PAYMENT.MENU** key and select "2 CREDIT 2" and enter the amount.

■ Mixed-tender sale (cash or check tendering + credit tendering)

Example	Key operation	Print
	}	
	#/TM/ST	1x 1.20 *1.20
	950 TL/NS	PLU00001
	CR1	1x 2.50 *2.50
		PLU00002
		3x 3.00 *9.00
		PLU00003
		***TOTAL *12.70
		CASH *9.50
		CREDIT1 *3.20

NOTE

Press the **CH1** key in place of the **TL/NS** key when your customer makes payment by checks.

Computation of VAT (Value Added Tax)/Tax

■ VAT/tax system

The cash register may be programmed for the following six VAT/tax systems. The cash register is pre-programmed as automatic VAT 1-4 system.

Automatic VAT 1 through 4 system (Automatic operation method using programmed percentages)

This system, at settlement, calculates VAT for taxable 1, taxable 2, taxable 3, and taxable 4 subtotals by using the corresponding programmed percentages.

Automatic tax 1 through 4 system (Automatic operation method using programmed percentages)

This system, at settlement, calculates taxes for taxable 1, taxable 2, taxable 3, and taxable 4 subtotals by using the corresponding programmed percentages, and also adds the calculated taxes to those subtotals, respectively.

Manual VAT 1 through 4 system (Manual entry method using programmed percentages)

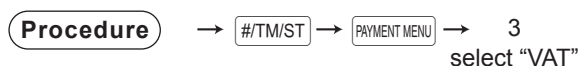

This system provides the VAT calculation for taxable 1, taxable 2, taxable 3, and taxable 4 subtotals. This calculation is performed using the corresponding programmed percentages when "VAT" from the payment menu is selected just after the #/TM/ST key.

Manual VAT 1 system (Manual entry method for subtotals that uses VAT 1 preset percentages)



This system enables the VAT calculation for the subtotal. This calculation is performed using the VAT 1 preset percentages when "VAT" from the payment menu is selected just after the #/TM/ST key. For this system, the keyed-in tax rate can be used.

Manual tax 1 through 4 system (Manual entry method using programmed percentages)

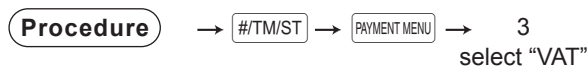

This system provides the tax calculation for taxable 1, taxable 2, taxable 3, and taxable 4 subtotals. This calculation is performed using the corresponding programmed percentages when "VAT" from the payment menu is selected just after the #/TM/ST key. After this calculation, you must finalize the transaction.

Automatic VAT 1 and tax 2 through 4

This system enables the calculation in the combination with automatic VAT 1 and tax 2 through 4. This combination can be any of VAT 1 and tax 2 through 4. The tax amount is calculated automatically with the percentages previously programmed for these taxes.

NOTE VAT/tax assignment is printed at the fixed right position of the amount on the receipt and bill as follows:

- VAT1/tax1 —————> A
- VAT2/tax2 —————> B
- VAT3/tax3 —————> C
- VAT4/tax4 —————> D

When the multiple VAT/tax is assigned to a department or a PLU, a smaller number of the VAT/tax will be printed.

Example

Key operation	Print
(When the MANUAL VAT 1 through 4 system is selected)	
8 <input type="text" value="PLU/EAN"/>	1x 9.60 *9.60
<input type="text" value="#/TM/ST"/>	PLU00008
<input type="text" value="PAYMENT MENU"/>	SUBTOTAL *9.60
3	-----
<input type="text" value="TL/NS"/>	TAX1 ST *9.60
	VAT 1 *0.28
	NET 1 *9.32

	CASH *9.60

Auxiliary Entries

■ Percent calculations (premium or discount)

- Your register provides percent calculations for a subtotal or each item entry depending on the programming.
- Percentage: 0.01 to 100.00%

Percent calculation for a subtotal

Example

Key operation		Print	
(When a discount of 10% is programmed for the %1 key.)	3 <input type="button" value="PLU/EAN"/> 2 <input type="button" value="⊗"/> 5 <input type="button" value="PLU/EAN"/> <input type="button" value="#/TM/ST"/> <input type="button" value="%1"/> <input type="button" value="TL/NS"/>	1x 3.00	*3.00
		PLU00003	
		2x 6.50	*13.00
		PLU00005	
		SUBTOTAL	*16.00
		%1	-10.00% -1.60
		CASH	*14.40

Percent calculation for item entries

Example

Key operation		Print	
(When a premium of 15% is programmed for the %1 key.)	6 <input type="button" value="PLU/EAN"/> <input type="button" value="%1"/> 30 <input type="button" value="PLU/EAN"/> 7 <input type="button" value="."/> 5 <input type="button" value="%1"/> <input type="button" value="TL/NS"/>	1x 8.00	*8.00
		PLU00006	
		%1	15.00% *1.20
		1x 5.00	*5.00
		PLU00030	
		%1	7.50% *0.38
		CASH	*14.58

NOTE

- You can also enter a percent calculation from the function menu window. Press the key and select "3 %2" and enter a percent calculation.
- Availability of item % and/or subtotal % depends on the programming data of %1 and %2.

■ Discount entries

Your register allows you to deduct a certain amount less than a programmed upper limit after the entry of an item or the computation of a subtotal depending on the programming.

Discount for a subtotal

Example

Key operation	Print														
6 <input type="button" value="PLU/EAN"/>	<table border="1"> <tr> <td>1x 5.75</td> <td>*5.75</td> </tr> <tr> <td>PLU00006</td> <td></td> </tr> <tr> <td>1x 12.00</td> <td>*12.00</td> </tr> <tr> <td>PLU00060</td> <td></td> </tr> <tr> <td>SUBTOTAL</td> <td>*17.75</td> </tr> <tr> <td>(-)</td> <td>-1.00</td> </tr> <tr> <td>CASH</td> <td>*16.75</td> </tr> </table>	1x 5.75	*5.75	PLU00006		1x 12.00	*12.00	PLU00060		SUBTOTAL	*17.75	(-)	-1.00	CASH	*16.75
1x 5.75		*5.75													
PLU00006															
1x 12.00		*12.00													
PLU00060															
SUBTOTAL		*17.75													
(-)	-1.00														
CASH	*16.75														
60 <input type="button" value="PLU/EAN"/>															
<input type="button" value="#/TM/ST"/>															
100 <input type="button" value="⊖"/>															
<input type="button" value="TL/NS"/>															
<input type="button" value="TL/NS"/>															

Discount for item entries

Example

Key operation	Print								
7 <input type="button" value="PLU/EAN"/>	<table border="1"> <tr> <td>1x 6.00</td> <td>*6.00</td> </tr> <tr> <td>PLU00007</td> <td></td> </tr> <tr> <td>(-)</td> <td>-0.75</td> </tr> <tr> <td>CASH</td> <td>*5.25</td> </tr> </table>	1x 6.00	*6.00	PLU00007		(-)	-0.75	CASH	*5.25
1x 6.00		*6.00							
PLU00007									
(-)		-0.75							
CASH		*5.25							
75 <input type="button" value="⊖"/>									
<input type="button" value="TL/NS"/>									
<input type="button" value="TL/NS"/>									
<input type="button" value="TL/NS"/>									

■ Refund entries

For a refund entry, press the key just before you press a department key, key, or key or just before you scan an EAN code. The operation before pressing the key is the same as the one of normal operation. For example, if a refund item is the one entered into a department, enter the amount of the refund, then press the key and the corresponding department key in this order; if an item entered into a PLU is returned, enter the corresponding PLU code, then press the and keys; and if a refund item is the one entered into an EAN, press the key and scan the EAN code.

Example

Key operation	Print										
3 <input type="button" value="RF"/> <input type="button" value="PLU/EAN"/>	<table border="1"> <tr> <td>-1x 3.00</td> <td>R-3.00</td> </tr> <tr> <td>PLU00003</td> <td></td> </tr> <tr> <td>-7x 6.00</td> <td>R-42.00</td> </tr> <tr> <td>PLU00007</td> <td></td> </tr> <tr> <td>CHANGE</td> <td>*45.00</td> </tr> </table>	-1x 3.00	R-3.00	PLU00003		-7x 6.00	R-42.00	PLU00007		CHANGE	*45.00
-1x 3.00		R-3.00									
PLU00003											
-7x 6.00		R-42.00									
PLU00007											
CHANGE		*45.00									
7 <input type="button" value="⊗"/>											
7 <input type="button" value="RF"/> <input type="button" value="PLU/EAN"/>											
<input type="button" value="TL/NS"/>											
<input type="button" value="TL/NS"/>											
<input type="button" value="TL/NS"/>											

■ Printing of non-add code numbers

Enter a non-add code number such as a guest code number within a maximum of 16 digits and press the **#/TM/ST** key at any point during the entry of a sale. The non-add code is printed on the receipt.

Example

Key operation	Print
1230 #/TM/ST	#0000000000001230
700 1	1x 7.00 *7.00
CR1	DPT. 01
	CREDIT1 *7.00

Payment Treatment

■ Currency exchange

Your register allows payment entries in foreign currency. Press the **EX** key to create a subtotal in foreign currency.

Procedure

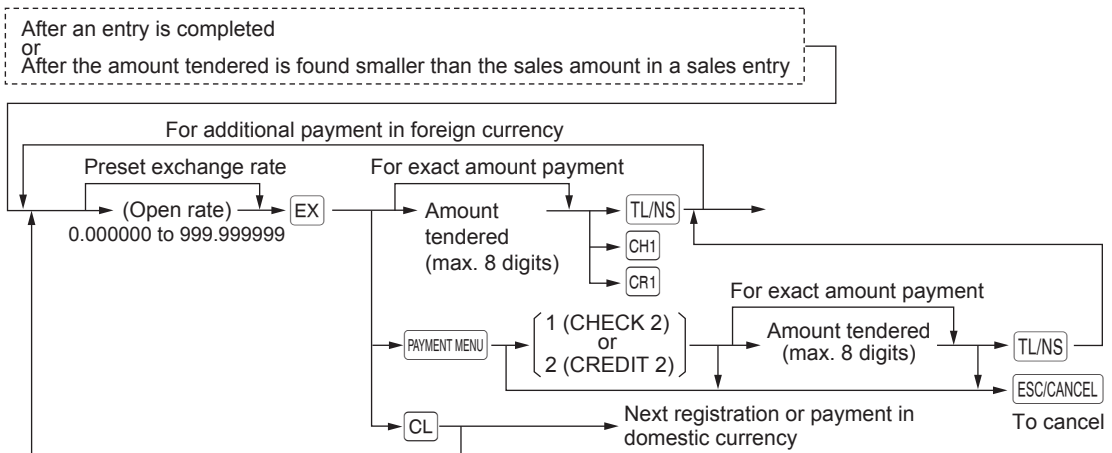

NOTE

- When the amount tendered is short, its equivalent in deficit is shown in domestic currency.
- Change amount will be displayed in domestic currency.
- Availability of credit and cheque tendering depends on the programming. (Only for the exchange 1)

Example

Preset exchange rate (1.550220) :EX1

Key operation	Print
Currency exchange → 6 PLU/EAN	1x 23.00 *23.00
→ 7 PLU/EAN	PLU00006
→ EX	1x 46.50 *46.50
Amount tendered in foreign currency → 12000 TL/NS	PLU00007
	***TOTAL *69.50
	EXCH1 1.550220
	107.74
	CASH 120.00
	CHANGE *7.90

■ Received-on-account entries

From the FUNCTION MENU, select RA option to proceed the operation. You cannot receive RA in foreign currency.

Procedure

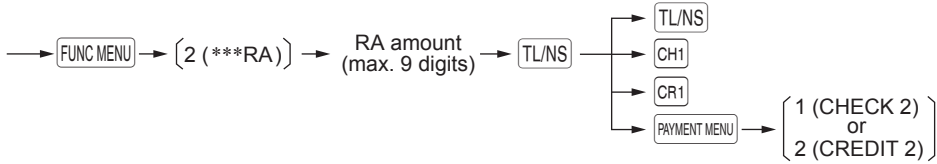

Example

Key operation

12345 #/TM/ST
 FUNC MENU
 (Selection "2 (***)RA") → 2
 4800 TL/NS
 CH1

Print

#0000000000012345	
CHECK1	
***RA	*48.00

■ Paid-out entries

You can make a payment by cash, check or credit.

Procedure

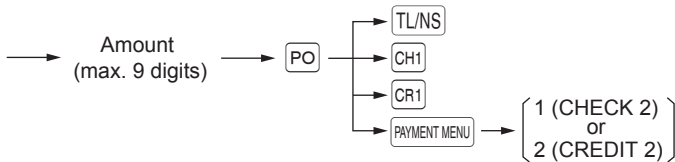

Example

Key operation

6789 #/TM/ST
 3000 PO
 TL/NS

Print

#0000000000006789	
CASH	
***PO	*30.00

■ No-sale (exchange)

Simply press the **[TL/NS]** key without any entry. The drawer will open and the printer will print "NO SALE" on the receipt. If you let your machine print a non-add code number before pressing the **[TL/NS]** key, a no sale entry is achieved with a non-add code number printed.

Print

NO SALE

■ Cashing a check

When you need to cash a check, enter the check amount and press a check key (**[CH1]**).

Example	Key operation	Print
	6789 [#TM/ST] 3000 [CH1]	<div style="border-bottom: 1px solid black; margin-bottom: 5px;">#000000000006789</div> CA/CHK *30.00

Electronic Journal View

The transaction data is kept in the electronic journal memory.

To display the journal data, press the **[EJ VIEW]** key, the last transaction data is displayed.

To retroact to past transaction data, press the **[EJ VIEW]** key repeatedly.

[EJ VIEW]	<pre> — EJ VIEW — 01#000016 02/07/11 19:12 1x 4.20 *4.20 PLU00004 1x 4.20 *4.20 PLU00003 [CANCEL] TO EXIT </pre>
[EJ VIEW]	<pre> — EJ VIEW — 01#000014 02/07/11 19:10 1x PLU00003 CASH *0.00 [CANCEL] TO EXIT </pre>

To exit the electronic journal view, press the **[ESC/CANCEL]** key.

TRAINING Mode

The training mode is used when the operator or the manager practices register operations.

When a clerk set in training is selected, the register automatically enters the training mode, while a clerk not set in training is selected, the register automatically enters the ordinary REG mode. A training text and a training clerk can be programmed.

The training operations are valid in all modes.

A mark which is identifying a training receipt is printed on the receipt which is issued in the training mode.

The consecutive number is not updated. The preceding number is repeated in printing.

Training clerk programming is performed in PGM mode.(It allows only for 1 Clerk.)

The memory in clerk is updated in the training mode. Other memories are not updated.

The reading and resetting of training clerks is printed on the clerk reports. However, the sales total of training clerks is not included in the clerk total on the full clerk report.

Key operation		Print
Selecting the clerk set in training	5	PLU/EAN
	3	⊗
	3	PLU/EAN
		TL/NS
		TRAINING
		1x 2.25 *2.25
		PLU00005
		3x 4.20 *12.60
		PLU00003
		CASH *14.85

Overlapped Clerk Entry

This function allows to switch from one clerk to another clerk and to interrupt the first clerk's entry. So the second clerk can do his or her entry in this mode. Interrupt handling is possible only in the overlapped clerk entry.

For actual use of this function, please change the programming of overlapped clerk function ("OVERLAPPED CLERK : YES/NO"). Please refer to "Basic System" in "Optional Feature Selection" programming.

NOTE

- The overlapped clerk entry is not effective while the tendering sale is going on.
- If any clerk is still making an entry (or has not finalized the transaction yet), the register does not run in any mode other than REG and MGR, and no X/Z reports can be printed. The message "CLERK REMAINED" and the related clerk are displayed.
- The overlapped clerk can be entered up to 5 clerks at the same timing, if the 6th clerk is entered, it cause the error.

Example

- Clerk 1: Entry started
- Clerk 2: Clerk change (1 to 2), interrupt initiated
- Clerk 2: Transaction finished
- Clerk 1: Clerk change (2 to 1), entry restarted

Key operation	Display
[Clerk 1 is assigned.] 1 <input type="text" value="CLK#"/> 1 <input type="text" value="PLU/EAN"/> 3 <input type="text" value="PLU/EAN"/> <input type="text" value="PLU/EAN"/>	
[Clerk 2 is assigned.] 2 <input type="text" value="CLK#"/> 3 <input type="text" value="⊗"/> 2 <input type="text" value="PLU/EAN"/> <input type="text" value="TL/NS"/>	
[Clerk 1 is assigned.] 1 <input type="text" value="CLK#"/> 1 <input type="text" value="PLU/EAN"/> 3 <input type="text" value="PLU/EAN"/> <input type="text" value="TL/NS"/>	

5 Correction

Correction of the Last Entry (Direct Void)

If you make an incorrect entry relating to a department, PLU/subdepartment, EAN, percentage (%1,%2), discount (⊖), or item refund, you can void this entry by pressing the ∞ key immediately.

Example

Key operation	Display										
1250 [1]	<table border="1"> <tr><td>1x12.50</td><td>12.50</td></tr> <tr><td>DPT.01</td><td></td></tr> <tr><td>***TOTAL</td><td>12.50</td></tr> <tr><td>DPT.01</td><td>12.50</td></tr> <tr><td>REG</td><td>01</td></tr> </table>	1x12.50	12.50	DPT.01		***TOTAL	12.50	DPT.01	12.50	REG	01
1x12.50		12.50									
DPT.01											
***TOTAL		12.50									
DPT.01	12.50										
REG	01										
[∞]											
2 [PLU/EAN]											
[∞]											
5012345678900 [PLU/EAN]	<table border="1"> <tr><td> </td><td> </td></tr> <tr><td> </td><td> </td></tr> <tr><td>***TOTAL</td><td>0.00</td></tr> <tr><td>DPT.01</td><td>V-12.50</td></tr> <tr><td>REG</td><td>01</td></tr> </table>					***TOTAL	0.00	DPT.01	V-12.50	REG	01
***TOTAL		0.00									
DPT.01	V-12.50										
REG	01										
[∞]											
600 [2]											
[%1]											
[∞]											
328 [3]	<table border="1"> <tr><td>DPT.03</td><td></td></tr> <tr><td>CASH</td><td>9.28</td></tr> <tr><td>***TOTAL</td><td>9.28</td></tr> <tr><td>REG</td><td>01</td></tr> </table>	DPT.03		CASH	9.28	***TOTAL	9.28	REG	01		
DPT.03											
CASH		9.28									
***TOTAL		9.28									
REG	01										
28 [⊖]											
[∞]											
250 [RF] [1]											
[∞]											
[TL/NS]											

Correction of the Next-to-Last or Earlier Entries (Indirect Void)

If you find an incorrect entry before finalizing the transaction (e.g. before pressing the **TL/NS** key), you can void the entry by the cursor operation or the key sequence operation.

Indirect void by cursor operation

You can void department, PLU/subdepartment, EAN, item refund, amount discount/premium and percent entries.

Move the cursor to the item to be voided, and press the **∞** key.

Indirect void by key sequence operation

You can void department, PLU/subdepartment, EAN and item refund.

Press the **∞** key just before you press a department key, **DEPT#** key or **PLU/EAN** key or just before you scan an EAN code. For the refund indirect void, press the **∞** key after you press the **RF** key.

Example

(Indirect void by cursor operation)

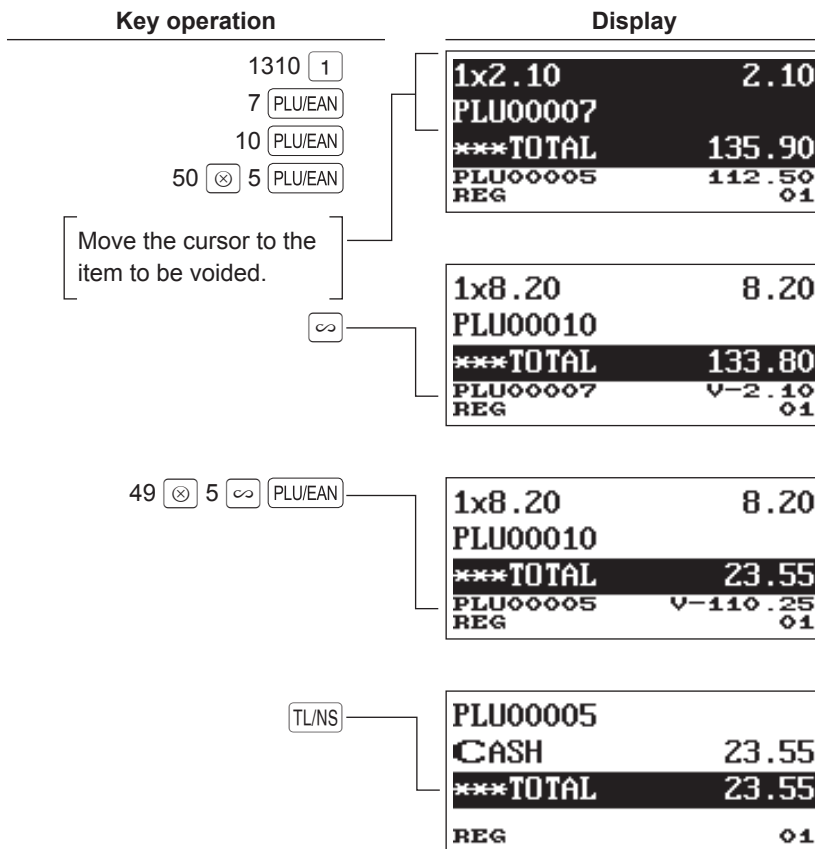

Subtotal Void

You can void an entire transaction. Once subtotal void is executed, the transaction is aborted and the register issues a receipt.

Example

Key operation	Display								
1 <input type="button" value="PLU/EAN"/>	<table border="0" style="width: 100%;"> <tr> <td style="width: 60%;">SBTL VOID</td> <td style="text-align: right;">-10.45</td> </tr> <tr> <td>***TOTAL</td> <td style="text-align: right;">0.00</td> </tr> <tr style="background-color: black; color: white;"> <td>***TOTAL</td> <td style="text-align: right;">0.00</td> </tr> <tr> <td>REG</td> <td style="text-align: right;">01</td> </tr> </table>	SBTL VOID	-10.45	***TOTAL	0.00	***TOTAL	0.00	REG	01
SBTL VOID		-10.45							
***TOTAL		0.00							
***TOTAL		0.00							
REG		01							
2 <input type="button" value="PLU/EAN"/>									
10 <input type="button" value="PLU/EAN"/>									
Subtotal void {	<input type="button" value="#/TM/ST"/>								
	<input type="button" value="∞"/>								
	<input type="button" value="#/TM/ST"/>								

Correction after Finalizing a Transaction

When you need to void incorrect entries that are found after finalizing a transaction or cannot be corrected by direct, indirect or subtotal void, follow this procedure.

1. Select "3 VOID MODE" in the SELECT mode.
2. Repeat the entries that are recorded on an incorrect receipt. (All data in the incorrect receipt is removed from register memory; the voided amounts are added to the void mode totalizer.)

Incorrect receipt		Cancellation receipt
--------------------------	--	-----------------------------

#000101	02/08/2011	19:00
01 CLERK01		000000
3x 1.20		*3.60
PLU00001		
1x 2.50		*2.50
PLU00002		
CASH		*6.10

➔

#000102	02/08/2011	19:05
01 CLERK01		000000
VOID MODE		
3x 1.20		*3.60
PLU00001		
1x 2.50		*2.50
PLU00002		
CASH		*6.10

NOTE Your register leaves the VOID mode whenever a transaction is canceled (i.e. finalized in the VOID mode). To void additional transactions, repeat steps 1 and 2. above.

6

Special Printing Function

Copy Receipt Printing

If your customer wants a receipt after you have finalized a transaction with the receipt ON-OFF function in the OFF status (no receipting), press the **FUNC MENU** key and "5" for receipting. Your register can also print a copy receipt when the receipt ON-OFF function is in the "ON" status.

Procedure

→ **FUNC MENU** → 5 (select "RCPT")

Example

Printing a receipt after making the entries shown below with the receipt ON-OFF function "OFF" status

Key operation	Print										
2 PLU/EAN											
3 ⊗											
1 PLU/EAN											
TL/NS											
For receipting → FUNC MENU 5	Print on the receipt										
	<table style="width: 100%; border-collapse: collapse;"> <tr> <td style="width: 60%;">1x 2.50</td> <td style="text-align: right;">*2.50</td> </tr> <tr> <td>PLU00002</td> <td></td> </tr> <tr> <td>3x 1.20</td> <td style="text-align: right;">*3.60</td> </tr> <tr> <td>PLU00001</td> <td></td> </tr> <tr> <td>CASH</td> <td style="text-align: right;">*6.10</td> </tr> </table>	1x 2.50	*2.50	PLU00002		3x 1.20	*3.60	PLU00001		CASH	*6.10
1x 2.50	*2.50										
PLU00002											
3x 1.20	*3.60										
PLU00001											
CASH	*6.10										

"COPY" is printed on the copy receipt.

COPY	
1x 2.50	*2.50
PLU00002	
3x 1.20	*3.60
PLU00001	
CASH	*6.10

Guest Check Receipt (Bill Print)

You can use this function when you want to take a bill for guest check.

Procedure

→ **FUNC MENU** → 1 (select "G.C.RCPT")

Operate it again, when you want to take a bill copy.

NOTE • *Bill copy is only once.*

Example

Key operation

1 **PLU/EAN**
TL/NS
FUNC MENU
 1

FUNC MENU
 1

Print

```

*BILL*
1x 1.20          *1.20
PLU00001
CASH          *1.20
  
```

```

*COPY*
*BILL*
1x 1.20          *1.20
PLU00001
CASH          *1.20
  
```

7 Manager Mode

The manager mode is used when managerial decisions must be made concerning register entries, for example, for overriding limitations and for other various non-programming managerial tasks.

NOTE Normal register operations may also be performed in this mode.

Entering the Manager Mode

To enter the manager mode, use the following procedure in the REG mode:

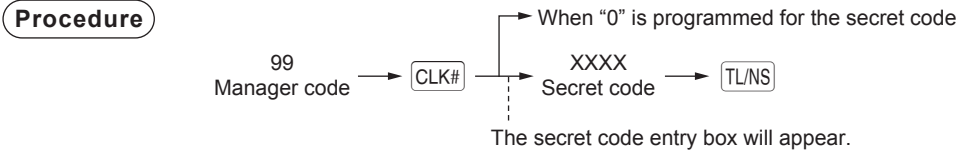

Example

If the code is correct, the register enters the manager mode.

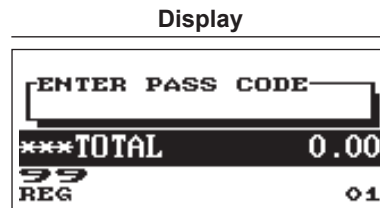

Override Entries

Programmed limits (such as maximum amounts) for functions can be overridden by placing the register in the manager mode.

Example This example presumes that the register has been programmed not to allow coupon entries over 2.00.

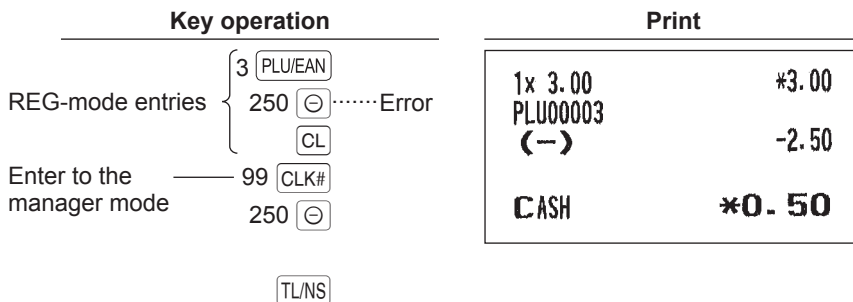

NOTE

- When a transaction is finalized, manager is automatically signed off.
- In the initial programming, the HALO function is programmed as "INVALID".

8

Reading (X) and Resetting (Z) of Sales Totals

- Use the reading function (X) when you need to take the reading of sales information entered after the last resetting. You can take this reading any number of times. It does not affect the register's memory.
- Use the resetting function (Z) when you need to clear the register's memory. Resetting prints all sales information and clears the entire memory except for the GT1 through GT3, reset count, and consecutive number.
- X1 and Z1 reports show daily sales information. You can take these reports in the X1/Z1 mode.
- X2 and Z2 reports show periodic (monthly) consolidation information. You can take these reports in the X2/Z2 mode.
- In the OP X/Z mode, a clerk can take his or her report.
- If you want to stop the printing report, press the **ESC/CANCEL** key.

■ How to take a X1/Z1 or X2/Z2 report

[To take an X1 or X2 report:]

1. Press the **MODE** key.
2. Select the "4 X1/Z1 MODE" or "5 X2/Z2 MODE" by using the **↓** key, and press the **TL/NS** key.
3. Select "2 READING" in the X1/Z1 mode or select "1 READING" in the X2/Z2 mode menu window and press in both cases **TL/NS** key to display the items list.
4. Select the appropriate report title.
5. Press the **TL/NS** key.

[To take a Z1 or Z2 report:]

1. Press the **MODE** key.
2. Select the "4 X1/Z1 MODE" or "5 X2/Z2 MODE" by using the **↓** key, and press the **TL/NS** key.
3. Select "3 RESETTING" in the X1/Z1 mode or select "2 RESETTING" in the X2/Z2 mode menu window and press in both cases **TL/NS** key to display the items list.
4. Select the appropriate report title.
5. Press the **TL/NS** key.

■ Flash report

You can take flash reports (display only) in the X1/Z1 mode for department sales, cash in drawer (CID) and sales total at the point you take the report.

1. Press the **MODE** key.
2. Select the "4 X1/Z1 MODE" by using **↓** key, and press the **TL/NS** key.
3. Select the "1 FLASH READ" , and press the **TL/NS** key.
4. Select "1 DEPT. SALES" to take a flash report of department sales, "2 CID" to take a flash report of cash in drawer, or "3 SALES TOTAL" to take a flash report of sales total.
5. Press the **TL/NS** key.

Report type	Description	Operating modes			Data to be entered
		OP X/Z	X1/Z1	X2/Z2	
GENERAL	General report		X1, Z1	X2, Z2	
<DEPT. MENU>					
BY RANGE	Department by group report		X1	X2	Department code (The range can be specified by entering start and end codes.)
BY GROUP	Individual department group report		X1	X2	Department group no. (1 to 12)
GROUP TOTAL	Department group total report		X1	X2	
<TRANS. MENU>					
TRANSACTION	Transaction report		X1	X2	
TL-ID	Total-in-drawer report		X1	X2	
<PLU/EAN MENU>					
BY RANGE	PLU/EAN sales report by specified range		X1, Z1	X2, Z2	PLU/EAN code (The range can be specified by entering start and end codes.)
BY DEPT	PLU/EAN report by associated department		X1, Z1	X2, Z2	Department code
PICK UP					
NEW PICKING	Pick up report by new codes		X1, Z1	X2, Z2	*1
LAST PICKING	Pick up report by the codes that were picked up the last time		X1, Z1	X2, Z2	*1
0 SALES					
ALL	PLU/EAN zero sales report		X1	X2	All PLU/EAN codes
BY DEPT	PLU/EAN zero sales report by associated department		X1	X2	Department code
<CLERK MENU>					
ALL CLERK	All clerk report		X1, Z1	X2, Z2	
IND. CLERK	Individual clerk report	X, Z	X1, Z1	X2, Z2	For the assigned clerk
HOURLY	Hourly report (all or by specified range)		X1		For an individual time range (The range can be specified by entering start and end times.)
	Hourly report (all)		Z1		
DAILY NET	Daily net report			X2, Z2	
E. JOURNAL	Electronic journal	X, Z	X1, Z1		

NOTE

*1: You can pick up PLU/EAN codes for issuing the report. You can pick up new PLU/EAN codes or the codes that were picked up the last time. To pick up new codes, select "1 NEW PICKING", and follow the procedure show below to pick up new codes. To pick up the codes that were picked up last time, select "2 LAST PICKING". Follow the following procedure for picking up PLU/EAN codes.

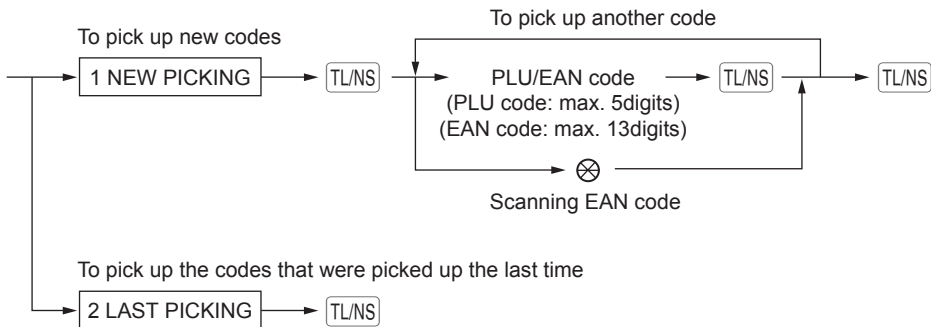

* The following reports relating to PLU/EAN is issued in the sequence of PLUs and EANs. PLU/EAN, PLU/EAN BY DEPT and PLU/EAN 0 SALES. Also the EAN codes are printed in the sequence shown below.

EAN-13
EAN-8
UPC-A
UPC-E
ITF-14

Daily Sales Totals

■ General report

• Sample X report

X1		Read symbol
DEPT. /GROUP		Report title
		Dept. code
		Sales q'ty
D01	55.000 Q	Dept. description and sales amount
DPT.01	*165.40	
	29.12%	
D02	29.000 Q	Dept. description and sales amount
DPT.02	*154.54	
	27.20%	
D03	24.000 Q	Dept. description and sales amount
DPT.03	*144.93	
	25.51%	
D06	9.000 Q	Dept. description and sales amount
DPT.06	*40.83	
	7.19%	
GROUP01	117.000 Q	Group 1 total q'ty
	*505.70	Group 1 total amount
	89.02%	Ratio of dept. group 1 sales amount to "+" dept. total

D04	9.000 Q	Dept. description and sales amount
DPT.04	*33.05	
	5.82%	
GROUP03	9.000 Q	Group 1 text
	*33.05	
	5.82%	

D05	6.000 Q	Dept. description and sales amount
DPT.05	*29.34	
	5.16%	

*DEPT TL	132.000 Q	{"+" dept. sales q'ty and total
	*568.09	
	100.00%	

D07	3.000 Q	{"-" dept. sales q'ty and total
DPT.07	-2.93	
DEPT (-)	3.000 Q	
	-2.93	

D08	6.000 Q	{"Hash "+" dept. sales q'ty and total
DPT.08	*21.43	
*HASH TL	6.000 Q	
	*21.43	

D09	2.000 Q	{"Hash "-" dept. sales q'ty and total
DPT.09	-1.47	
HASH (-)	2.000 Q	
	-1.47	

• Sample Z report

Z1		Reset counter
	21 0003	Net grand total (GT2-GT3)
GT1	*00000001021.67	Grand total of plus registration
GT2	*00000001398.52	Grand total of minus registration
GT3	-00000000376.85	Grand total of training-mode registrations
TR	*00000000000.00	

DEPT. /GROUP		

↓
The subsequent printout occurs in the same format as in the sample X1 report.

TRANSACTION		Report title
(-)	2 Q	Subtotal (-) counter and total
	-3.25	
%1	2 Q	Subtotal % counter and total
	-0.58	
NET 1	*565.16	Net sales total

TAX1 ST	*442.40	Taxable 1 total
VAT 1	*57.70	VAT 1 total
TAX2 ST	*163.52	
VAT 2	*23.76	
TAX3 ST	*152.03	
VAT 3	*11.26	
TAX4 ST	*20.80	
VAT 4	*2.06	
TTL TAX	*94.78	Total tax
NET	*470.38	NET sales without tax

(-)	3 Q	Item (-) counter and total
	-0.88	
%2	3 Q	Item % counter and total
	-1.59	
REFUND	2 Q	Refund counter and total
	*3.82	
VOID	4 Q	Item void counter and total
	*14.91	
VOID MODE	1 Q	Void-mode transaction counter and total
	*8.55	
MGR VOID	4 Q	Void mode item counter and total
	*8.55	
SBTL VOID	1 Q	Subtotal void counter and total
	*3.92	
HASH VOID	1 Q	Hash item void counter and total
	*1.20	
HASH RF	1 Q	Hash item refund counter and total
	*1.21	

BILL CNT	2 Q	Bill print counter
NO SALE	4 Q	No-sale (exchange) counter
GUEST	50 Q	Transaction counter

The net sales with tax (NET2) will be printed in case add-on tax system is included.

PAID TL	*585.12	Paid total
AVE.	*11.70	Paid total average per transaction counter
SCM(+)	*120.00	Starting cash memory (+)
SCM(-)	-50.00	Starting cash memory (-)
SCM TTL	*70.00	Starting cash memory total
***RA	1 Q	Received-on-account counter and total
	*100.00	
***PO	1 Q	Paid-out counter and total
	*30.00	
CA/CHK	3 Q	Check cashing counter and total
	*57.00	

CASH	34 Q	Cash counter and total
	*361.91	
CHECK1	4 Q	Check sale counter and total
	*49.50	
CHECK2	2 Q	
	*12.50	
CREDIT1	3 Q	Credit sale and tendering counter and total
	*72.46	
CREDIT2	2 Q	
	*11.30	
EXCH1	1 Q	Exchange 1 cash counter and total
	15.00	
DOM. CUR1	*9.67	(Exchange 1 : for the programmed rate)
EX1 CHK	4 Q	(Exchange 2 : for the open rate)
	80.00	
DOM. CUR1 CHK	*51.57	
EX1 CR	2 Q	
	19.70	
DOM. CUR1 CR	*12.70	
EXCH2	1 Q	
	20.00	
DOM. CUR2	*12.89	

****CID	*435.53	Cash in drawer
*CH ID	*119.00	Check in drawer
CA/CHK ID	*554.53	Cash+check in drawer
CHK/CG	*7.02	Change total for check tendering
OVCS REMAIN	*0.00	Overlapped clerk opened amount

■ Department report

X1		
DEPT./GROUP		Dept. code
D01	55.000 Q	Dept. description
DPT. 01	*165.40	Sales q'ty
	29.12%	Sales amount
		Ratio of dept. 1 sales amount to "+" dept. total
D02	29.000 Q	
DPT. 02	*154.54	
	27.20%	
D03	24.000 Q	
DPT. 03	*144.93	
	25.51%	
D06	9.000 Q	
DPT. 06	*40.83	
	7.19%	
GROUP01	117.000 Q	Group 1 total sales q'ty
	*505.70	Group 1 total sales amount
	89.02%	Ratio of dept. group 1 sales amount to "+" dept. total
		Group 1 text

D04	9.000 Q	
DPT. 04	*33.05	
	5.82%	
GROUP03	9.000 Q	
	*33.05	
	5.82%	

D05	6.000 Q	
DPT. 05	*29.34	
	5.16%	
GROUP09	6.000 Q	
	*29.34	
	5.16%	

*DEPT TL	132.000 Q	} "+" dept. counter and total
	*568.09	
	100.00%	

D07	3.000 Q	} "-" dept. sales q'ty and total
DPT. 07	-2.93	
DEPT (-)	3.000 Q	
	-2.93	

D08	6.000 Q	} "Hash "+" dept. sales q'ty and total
DPT. 08	*21.43	
*HASH TL	6.000 Q	
	*21.43	

D09	2.000 Q	} "Hash "-" dept. sales q'ty and total
DPT. 09	-1.47	
HASH (-)	2.000 Q	
	-1.47	

■ Individual group total report on departments

X1	
DEPT.	IND. GROUP
D01	55.000 Q
DPT. 01	*165.40
D02	29.000 Q
DPT. 02	*154.54
D03	24.000 Q
DPT. 03	*144.93
D06	9.000 Q
DPT. 06	*40.83
GROUP01	117.000 Q
	*505.70

Dept. code
 Dept.description
 Sales q'ty
 Sales amount
 Group 1 text/sales q'ty and total

■ Full group total report on departments

X1	
GROUP TOTAL	
GROUP01	117.000 Q
	*505.70
	89.02%
GROUP03	9.000 Q
	*33.05
	5.82%
GROUP09	6.000 Q
	*29.34
	5.16%
*DEPT TL	132.000 Q
	*568.09
	100.00%

DEPT (-)	3.000 Q
	-2.93

*HASH TL	6.000 Q
	*21.43

HASH (-)	2.000 Q
	-1.47

"+" dept. counter and total
 "-" dept. sales q'ty and total
 "Hash "+" dept.sales q'ty and total
 "Hash "-" dept.sales q'ty and total

Transaction report

X1		
TRANSACTION		
*DEPT TL	227.000 Q	Plus dept. total
	*902.29	
DEPT (-)	3.000 Q	Minus dept. total
	-2.93	
*HASH TL	6.000 Q	Plus hash dept. total
	*21.43	
HASH (-)	2.000 Q	Minus hash dept. total
	-1.47	
(-)	2 Q	
	-3.25	
%1	2 Q	
	-0.58	
NET 1	*899.36	

TAX1 ST	*760.70	
VAT 1	*99.22	
TAX2 ST	*179.42	
VAT 2	*26.07	
TAX3 ST	*152.03	
VAT 3	*11.26	
TAX4 ST	*20.80	
VAT 4	*2.06	
TTL TAX	*138.61	
NET	*760.75	



In this report, the same transaction data as those printed in the general report are printed.

Total in drawer report

X1		
TL-ID		
EXCH1	1 Q	Exchange 1 counter
	15.00	Currency exchange 1 total
DOM. CUR1	*9.67	
EX1 CHK	4 Q	Domestic currency for currency exchange 1 total
	80.00	
DOM. CUR1 CHK	*51.57	
EX1 CR	2 Q	
	19.70	
DOM. CUR1 CR	*12.70	
EXCH2	1 Q	
	20.00	
DOM. CUR2	*12.89	

****CID	*769.73	Cash in drawer
*CH ID	*119.00	Check in drawer
CA/CHK ID	*888.73	Cash + check in drawer

■ PLU/EAN report by designated range

X1		*
PLU/EAN		
00001-99999999999999		PLU/EAN range
PLU		
P00001	11.000 Q	PLU code/description, sales q'ty and sales amount
PLU00001	*23.10	
P00002	9.000 Q	
PLU00002	*28.44	
P00003	5.000 Q	
PLU00003	*26.05	
P00004	5.000 Q	
PLU00004	*31.00	
P00005	8.000 Q	
PLU00005	*40.96	
P00006	9.000 Q	
PLU00006	*27.18	
P00007	6.000 Q	
PLU00007	*9.60	
P00008	15.000 Q	
PLU00008	*37.95	
P00009	6.000 Q	
PLU00009	*45.12	

***TOTAL	74.000 Q	Total sales q'ty and amount for PLUs
	*269.40	

EAN		EAN code
5012345678900#	9.000 Q	Description, sales q'ty and sales amount
Item-A	*27.90	
5045678901230#	6.000 Q	
Item-B	*13.20	
5087654321106#	3.000 Q	
Goods-A	*15.90	
5099887654302#	3.000 Q	
DPT. 05	*7.80	

***TOTAL	21.000 Q	Total sales q'ty and amount for EANs
	*64.80	

* When you take a Z report, "Z1" is printed instead of "X1".

NOTE In case of a PLU/EAN X report only header information is stored in the Electronic Journal file.

■ PLU/EAN report by associated department

X1		*
PLU/EAN BY DEPT		
DPT. 02	D02	Description of associated dept
PLU		Associated dept. code
P00002	9.000 Q	PLU code
PLU00002	*28.44	Description, sales q'ty and sales amount
P00003	5.000 Q	
PLU00003	*26.05	

***TOTAL	14.000 Q	PLU total of associated department
	*54.49	

EAN		EAN code
5087654321106#	3.000 Q	Description, sales q'ty and sales amount
Goods-A	*15.90	
***TOTAL	3.000 Q	EAN total of associated department
	*15.90	

■ PLU/EAN zero sales report (full)

X1		
PLU/EAN 0 SALES		
PLU		PLU code
P00010	PLU00010	Description
P00011	PLU00011	
P00012	PLU00012	
P00013	PLU00013	
P00014	PLU00014	
P00015	PLU00015	
P00016	PLU00016	

EAN		EAN code
4901991005936#	Materials-1	Description
4901991641585#	Materials-2	

* When you take a Z report, "Z1" is printed instead of "X1".

■ PLU/EAN zero sales report (by dept.)

X1		
PLU/EAN 0 SALES		
DPT. 02	D02	Description of dept.
PLU		Associated dept. code
P00010	PLU00010	
P00011	PLU00011	
P00015	PLU00015	

EAN		
4901991005936#	Materials-1	

■ Individual clerk report

X1		*
IND. CLERK		Clerk code
CLK#01	CLERK01	Clerk name
PAID TL	*1059.70	Paid total
AVE. REFUND	*19.62	Paid total average per transaction counter
	3 Q	Refund counter and total
	*5.03	
VOID	5 Q	Item void counter and total
	*16.11	
VOID MODE	1 Q	Void-mode transaction counter and total
	*8.55	
MGR VOID	4 Q	Void mode item counter and total
	*8.55	
SBTL VOID	1 Q	Subtotal void counter and total
	*3.92	
GUEST	54 Q	Transaction counter

SCM(+)	*120.00	Starting cash memory (+)
SCM(-)	-50.00	Starting cash memory (-)
SCM TTL	*70.00	Starting cash memory total
***RA	1 Q	Received-on-account counter and total
	*100.00	
***PO	1 Q	Paid-out counter and total
	*30.00	
CA/CHK	3 Q	Check cashing counter and total
	*57.00	

CASH	38 Q	Cash counter and total
	*836.49	
CHECK1	4 Q	Check 1 sale counter and total
	*49.50	
CHECK2	2 Q	
	*12.50	
CREDIT1	3 Q	Credit 1 sale and tendering and total
	*72.46	
CREDIT2	2 Q	
	*11.30	
EXCH1	1 Q	Exchange 1 counter and total
	15.00	
DOM. CUR1	*9.67	
EX1 CHK	4 Q	
	80.00	
DOM. CUR1 CHK	*51.57	
EX1 CR	2 Q	
	19.70	
DOM. CUR1 CR	*12.70	
EXCH2	1 Q	
	20.00	
DOM. CUR2	*12.89	

****CID	*910.11	Cash in drawer
*CH ID	*119.00	Check in drawer
CA/CHK ID	*1029.11	Cash + check in drawer
CHK/CG	*7.02	Change total for check tendering

■ All clerk report

X1		*
ALL CLERK		
CLK#01	CLERK01	



The subsequent printout occurs in the same format as in the individual clerk report from the clerk #1. In the full clerk report, the total sales of all clerks are also printed.

* When you take a Z report, "Z1" is printed instead of "X1."

Hourly report

X1		*
HOURLY		Time
18:00	12 Q	Transaction counter
	*122.00	Sales total
AVE. 18:30	*10.17	Average of sales amount
	4 Q	
	*175.87	
AVE.	*43.97	
SUBTOTAL	16 Q	
	*297.87	

AVE.	*79.24
22:30	0 Q
	*0.00
AVE.	*0.00
SUBTOTAL	3 Q
	*237.71

* When you take a Z report, "Z1" is printed instead of "X1."

Periodic Report Sample

Your register allows you to take consolidation X and Z reports of a chosen period (the period is usually one week or month).

■ General information

The periodic reading or resetting reports are the same in format as those in the X1/Z1 report for daily sales information except mode indication (“X2” or “Z2”).

• Sample X report

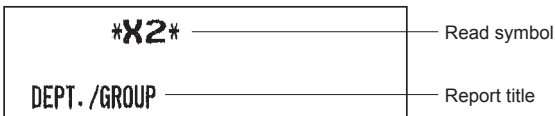

• Sample Z report

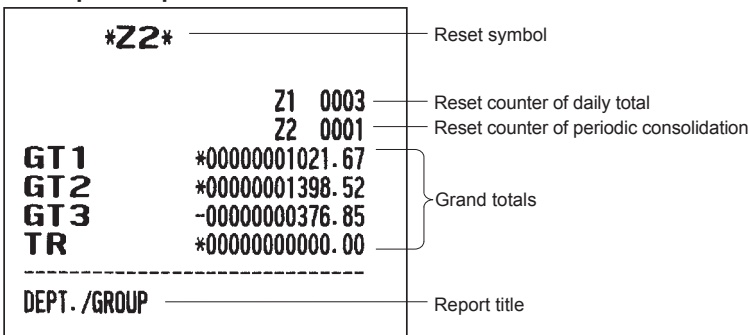

The subsequent items are printed out in the same format as in the X/Z report on daily totals.

■ Daily net report

X2		When you take a Z report, "Z2" is printed instead of "X2".
DAILY NET		
01/08	28 Q	Date
	*573.19	Transaction counter
		Sales total
02/08	40 Q	
	*11100.66	
<hr/>		
30/08	65 Q	
	*8769.25	
31/08	28 Q	
	*7717.00	
***TOTAL	394 Q	Total of transaction counter
	*979448.63	Total of sales total

Compulsory Cash/Check Declaration

If your register has been programmed for compulsory cash/check declaration, you must declare cash/check in drawer in advance according to the type of the declaration when you take clerk Z reports.

Use the procedure shown in the procedure below for this declaration.

Procedure

• Individual clerk Z report

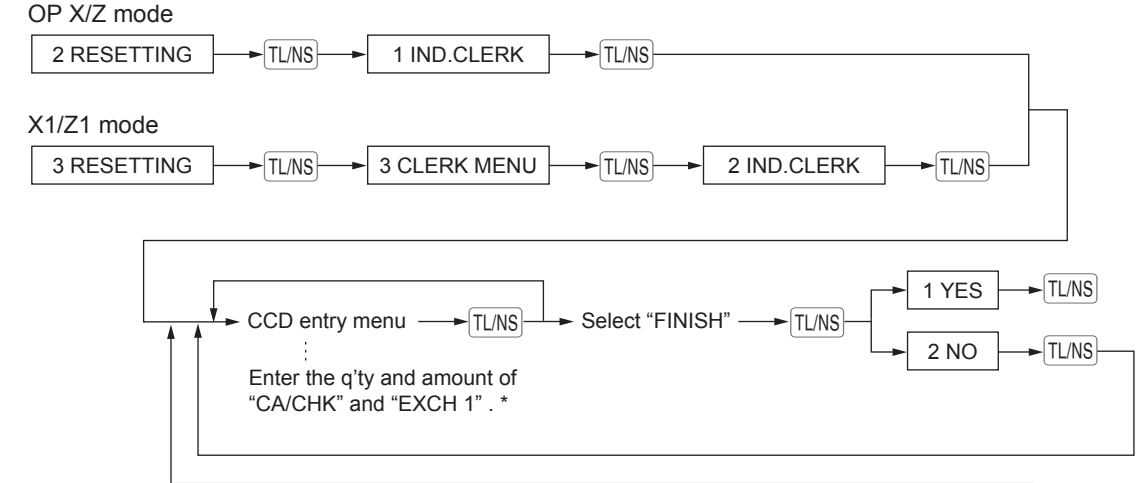

• Full clerk Z report



* If you make a wrong entry, press the **ESC/CANCEL** key and make a correct entry.

NOTE To use this function, program the compulsion of CCD entry ("CCD Function" in the Report Programming section).

■ Display sample

```

CCD ENTRY
CA/CHK IS *0.00
EXCH1 IS 0.00
FINISH

OPXZ 01
    
```

< CCD data menu window >

```

CA/CHK IS
QUANTITY 0
AMOUNT 0.00

OPXZ 01
    
```

< CA/CHK data entry window >

```

EXCH1 IS
QUANTITY 0
AMOUNT 0.00

OPXZ 01
    
```

< Exchange data entry window >

NOTE (QUANTITY) x (AMOUNT) = Total for "CA/CHK" or "EXCH1"

■ Report sample

```

*Z1*
*CCD*
CA/CHK IS *1394.42
EXCH1 IS 180.00
-----
IND. CLERK *
CLK#01 CLERK01
PAID TL *1502.00
AVE. *18.78
REFUND 4.0
    
```

} CCD entry amount

```

CREDIT2
EXCH1 *12.24
180.00
EXCH1 IS 2 Q
180.00
CCD DIF. 0.00
DOM. CUR1 *116.09
EX1 CHK 1 Q
12.00
DOM. CUR1 CHK *7.73
EX1 CR 1 Q
33.52
DOM. CUR1 CR *21.62
EXCH2 1 Q
20.00
DOM. CUR2 *12.89
-----
****CID *1231.42
*CH ID *163.00
CA/CHK ID *1394.42
CA/CHK IS *1394.42
CCD DIF. *0.00
DIF. TL *0.00
CHK/CG *15.48
    
```

Exchange 1 to be obtained (1)
Declared exchange 1 in drawer (2)

Difference (3)=(2)-(1)

Cash/check in drawer to be obtained (4)

Declared cash/check in drawer (5)

Difference (6)=(5)-(4)

Total of difference (3)+(6)

Change total for tendering

*When you take a full clerk report, ALL CLERK is printed here.

9

Non-accessed EAN Deletion

You can delete EANs that had not been accessed for a certain period. You can program a period in the PGM mode.

Follow the procedure shown below.

Non-accessed EAN deletion

1. Select the X1/Z1 mode from the mode selection screen.
2. Select "4 EAN DELETE".
3. Select "1 READING" to take a report, or "2 DELETE" to delete non-accessed EANs.
4. When you select "2 DELETE", select you want to delete all the non-accessed EANs (1 ALL DELETE) or delete the non-accessed EANs individually (2 IND.DELETE).

NOTE It is recommended to take a report first before executing deletion operation.

■ Non-accessed EAN report

*1 *X1*		
EAN DELETE		
EAN code		
4901991005936#		0.000 Q
Description	Materials-1	*0.00
4901991641585#		0.000 Q
	Materials-2	*0.00
5012345678900#		0.000 Q
	Item-A	*0.00
	Z2	9.000 Q
		*27.90
5087654321106#		0.000 Q
	Goods-A	*0.00
	Z2	3.000 Q
		*15.90
5099887654302#		0.000 Q
	DPT. 05	*0.00
	Z2	3.000 Q
		*7.80

*2

*1 When you select "DELETE", "Z1" is printed instead of "X1".

*2 When there is any sales data of the EAN for PLU/EAN report, the data is printed here.

When you delete the EAN in Z1 mode under this situation, the EAN data for PLU/EAN report is also deleted.

10 Prior to Programming

When you are in the PGM mode, the keyboard layout will be set to one of the programming layouts as shown below.

Programming Keyboard Layout

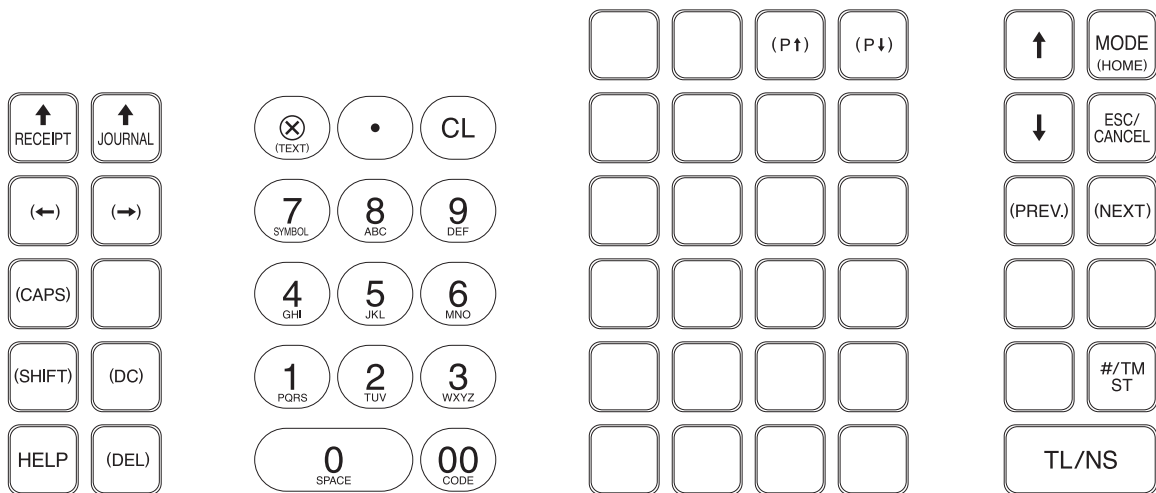



: Used for programming characters. For more information about programming characters, see the section “How to Program Alphanumeric Characters.” Also the (DEL) key is used to delete the record item.



: Used to move the cursor.



: Used to program each setting and to finalize programming.



: Used to cancel programming and to get back to the previous screen.



: Used to go back to the previous record, e.g., from the department 2 programming window back to the department 1 programming window.



: Used to go to the next record, for example, in order to program unit prices for sequential departments.



: Used to scroll the window to go to the next page.



: Used to scroll the window to go back to the previous page.



: Used to clear the last setting you have programmed or clear the error state.



: Used to toggle between two or more options.



: Used to list those options which you can toggle by the • key.

Numeric keys : Used for entering figures.

How to Program Alphanumeric Characters

This section discusses how to program alphanumeric characters for various texts.

■ Mobile phone method

Entering alphanumeric characters

To enter a character, simply press a corresponding character key on the programming keyboard.

To enter “A”, press the “8” key.

To enter “B”, press the “8” key twice.

To enter “C”, press the “8” key three times.

Entering double-size characters

 : This key toggles the double-size character mode and the normal-size character mode. The default is the normal-size character mode. When the double-size character mode is selected, the letter “W” appears at the bottom of the display.

Entering upper-case letters

 : You can enter an upper-case letter by using this key. Press this key just before you enter the upper-case letter. You should press this key each time you enter an upper-case letter.

 : You can lock the upper-case letter mode once the this key is pressed.

Entering space

 : Enter a space in the cursor position.

To move the cursor

  : Moves the cursor.

To delete a character or figure

 : Deletes a character or figure in the cursor position.

To change the text input mode

 : This key toggles the text input mode, Alphabet (A), European character (Ä), numeric (1), and symbol (*).

■ Entering character codes

Numerals, letters and symbols are programmable by entering the **00** key and character codes. Use the following procedure with the cursor placed at the position where you want to enter characters:

To enter a digit, simply press a corresponding numeric key.

→ **00** → XXX XXX : character code (3 digits)

Character code:

032 - 047	032	033	034	035	036	037	038	039	040	041	042	043	044	045	046	047
		!	"	#	\$	%	&	'	()	*	+	,	-	.	/
048 - 063	048	049	050	051	052	053	054	055	056	057	058	059	060	061	062	063
	0	1	2	3	4	5	6	7	8	9	:	;	<	=	>	?
064 - 079	064	065	066	067	068	069	070	071	072	073	074	075	076	077	078	079
	@	A	B	C	D	E	F	G	H	I	J	K	L	M	N	O
080 - 095	080	081	082	083	084	085	086	087	088	089	090	091	092	093	094	095
	P	Q	R	S	T	U	V	W	X	Y	Z	[\]	^	_
096 - 111	096	097	098	099	100	101	102	103	104	105	106	107	108	109	110	111
	`	a	b	c	d	e	f	g	h	i	j	k	l	m	n	o
112 - 127	112	113	114	115	116	117	118	119	120	121	122	123	124	125	126	127
	p	q	r	s	t	u	v	w	x	y	z	{		}	~	Δ
128 - 143	128	129	130	131	132	133	134	135	136	137	138	139	140	141	142	143
	Ç	ü	é	â	ä	à	ã	ç	ê	ë	è	ï	î	ì	Ä	Å
144 - 159	144	145	146	147	148	149	150	151	152	153	154	155	156	157	158	159
	É	æ	ƒ	ô	ö	ò	û	ù	ÿ	ö	Ü	ø	£	Ø	x	f
160 - 175	160	161	162	163	164	165	166	167	168	169	170	171	172	173	174	175
	á	í	ó	ú	ñ	Ñ	ª	º	¿	®	€	½	¼	¡	«	»
176 - 191	176	177	178	179	180	181	182	183	184	185	186	187	188	189	190	191
	⋮	⋮	⋮		´	Á	Â	À	©	ë		ñ	ƒ	Ç	¥	§
192 - 207	192	193	194	195	196	197	198	199	200	201	202	203	204	205	206	207
	ƒ	à	æ	ç	-	ð	ã	Ã	ë	Ñ	Ř	š	ť	=	Ó	ø
208 - 223	208	209	210	211	212	213	214	215	216	217	218	219	220	221	222	223
	š	Đ	Ê	Ë	È	€	Í	Î	Ï	Ž	Γ	■	■	¡	ì	■
224 - 239	224	225	226	227	228	229	230	231	232	233	234	235	236	237	238	239
	Ó	ß	Ô	Ò	Õ	Ö	µ	þ	Þ	Ú	Û	Ù	Ý	Ý	-	'
240 - 255	240	241	242	243	244	245	246	247	248	249	250	251	252	253	254	255
	-	±	=	¼	¶	§	÷	,	°	¨	.	1	3	2	■	(DC)

*(DC) : Double-size character code

11 Programming

This chapter explains how to program various items.

Before you start programming, press the **MODE** key and select the "6 PGM MODE" or "7 SD CARD MODE" by using the **↓** key and press the **TL/NS** key.

Basic Instructions

This section illustrates the basic programming by using an example of programming for departments.

■ Programming screen

Opening screen: When you select the "6 PGM MODE", your display will show a programming opening screen corresponding to the mode you selected.

Mode you are in

PGM MODE
1 READING
2 SETTING

PGM 01

Programming menu: Use the cursor keys or numeric key to select an option, and press the **TL/NS** key.

Numeric entry and status information area

Code selecting screen (Dept. PLU):

Selected menu/option

PLU/EAN ▼

00001 PLU00001
00002 PLU00002

PGM 01

Code number and its description
(In case of PLU/EAN, two lines are used for one code, upper line - code, lower line - description.)
Use the cursor keys or numeric keys to select an option, and press the **TL/NS** key.

Numeric entry and status information area

Programming screen:

Selected code

00001 PRICE 0.00 PLU00001 PRESET

DEPT .CODE 01
NON-ACCESS NON DEL.

PGM 01

Setting items:
Use the cursor keys to select an item.
To select an option, follow the instruction shown below.
Numeric entry: Use numeric keys
Character entry: Use character keys
Selective entry: Press **[.]** key to toggle options, or press the **#TM/ST** key to show the option list. Use the cursor keys to move the cursor and press the **#TM/ST** or **TL/NS** key to select it.

■ Programming example

Procedure

```

PGM MODE
1 READING
2 SETTING
-----
PGM                                01
  
```

TL/NS ↓ ↑ ESC/CANCEL

```

SETTING
1 ARTICLE
2 FUNCTIONS
3 MEDIA
4 FUNCTION TEXT
5 PERSONNEL
-----
PGM                                01
  
```

TL/NS ↓ ↑ ESC/CANCEL

```

ARTICLE
1 DEPARTMENT
2 PLU/EAN
3 PLU RANGE
4 EAN NON-PLU
5 EAN DELETE
-----
PGM                                01
  
```



TL/NS ↓ ↑ ESC/CANCEL

```



DEPARTMENT
01 DPT.01
02 DPT.02
03 DPT.03
04 DPT.04
05 DPT.05
-----
PGM                                01
  
```

TL/NS ↓ ↑ ESC/CANCEL

The following example shows how to program 2.00 for the unit price, "ABCDE" for the description, and "non-taxable 1" for department 1.

1. In the PGM MODE screen, select "2 SETTING" by using the  key and press the  key.
 - The SETTING screen will appear.





NOTE

- You can also select "2 SETTING" by using numeric key "2," then press the  key.
- If you return to the previous screen, press the  key.

2. Select "1 ARTICLE."

 - The ARTICLE screen will appear.

NOTE

The arrow mark in the upper-right corner of the window shows that the window contains more options than are now on the screen. To scroll the window, press the  or  key. To return to the previous page, press the  or  key.

3. Select "1 DEPARTMENT."

 - The DEPARTMENT screen will appear, listing programmable departments.

4. Select "01 DPT.01" to program for department 1.
 - The "01" window will appear.

```

01
PRICE      200
          DPT . 0 1
TYPE
TAX1
TAX2
TAX3
PGM
          OPEN
          YES
          NO
          NO
          01

```

```

01
PRICE      2.00
          ABCDE
TYPE
TAX1
TAX2
TAX3
PGM      a
          OPEN
          YES
          NO
          NO
          01

```

```

01
PRICE      2.00
          ABCDE
TYPE
TAX1
TAX2
TAX3
PGM
          OPEN
          NO
          NO
          01

```

5. On the first page of the “01” window, program the unit price and description as follows:

NOTE

There are three entry patterns for the programming: the numeric entry, character entry, and selective entry.

- Move the cursor to “PRICE,” enter “200” by using numeric keys. → Numeric entry
- Move the cursor to “DPT.01,” enter “ABCDE” by using character keys. → Character entry

If you want to clear setting, press the key before you press the , , , or key.

6. Press the key twice to move to the cursor to “TAX 1”, then program the machine to set “non-taxable 1” as follows:

- Press the key to select “NO.” → Selective entry

NOTE

The key toggles between two options as follows:

NO → YES → NO →

Pressing the key displays all pertinent options.

7. Select one of the following actions:

- To cancel the programming, press the key. A confirmation window appears to ask you whether to save the data; select the option you prefer.
- To finalize the programming, press the key, then press the key. You will return to the “DEPARTMENT” window.
- To program for the following department, press the key. The “02” window will appear. To return to the “01” window, press the key.

The following sections describe how to program each item which is contained in a programming group.

Article Programming

Use the following procedure to select any option included in the article programming group:

Procedure

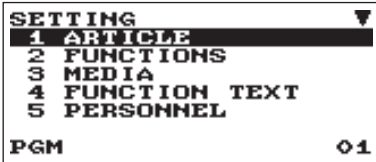

1. In the SETTING window, select “1 ARTICLE.”
 - The ARTICLE window will appear.

2. Select any option from the following options list.

1 DEPARTMENT :	Departments
2 PLU/EAN :	PLUs/EANs
3 PLU RANGE :	A range of PLUs
4 EAN NON-PLU :	EAN Non-PLU type code format
5 EAN DELETE :	EAN delete

The following illustration shows those options included in this programming group.

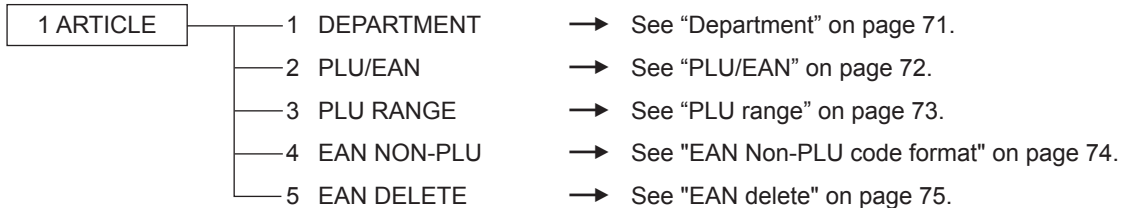

■ Department

The register can be equipped with maximum of 99 departments.

Use the following procedure to program for department.

NOTE To delete a department item in the "DEPARTMENT" window, select the item and press the  key. A confirmation window appears to ask you whether to delete the item, select the option you prefer.

Procedure

Select a pertinent dept. code from the departments list.



```

01 PRICE          0.00
DPT. 01
TYPE             OPEN
TAX1             YES
TAX2             NO
TAX3             NO
PGM              01
    
```

The screen continues.

Program each item as follows:

NOTE

For more information about the entry patterns, see the "Basic Instructions" section.

• PRICE (Use the numeric entry)

Unit price (max. 8 digits)

• Description (Use the character entry)

Description for a department. Up to 16 characters can be entered. (Default text: DPT.nn)

• TYPE (Use the selective entry)

Type of unit price entry for departments

INHIBIT: Inhibited

OPEN: Open only

PRESET: Preset only

OPEN & PRESET: Open & preset

• TAX 1 through 4 (Use the selective entry)

Taxability

YES : Taxable

NO : Non-taxable

NOTE The tax system of your register has been factory-set to automatic VAT1 - 4.

• SICS (Use the selective entry)

Department type selection

YES: SICS department

NO: Normal department other than SICS department

• GROUP No. (Use the numeric entry)

01-09: Plus department

10: Minus department

11: Plus hash department

12: Minus hash department

• HALO (Use the numeric entry)

This function is intended for prevention of accidentally entered unreasonably amounts.

Limit amount: 0.00 to 999999.99

NOTE In the initial programming, the HALO function is programmed as "INVALID".

■ PLU/EAN

NOTE

- In this manual, the word "EAN" represents EAN (European Article Number) and UPC (Universal Product Code).
- With regard to the EAN codes applicable to this register, please refer to the chapter 13.
- To delete a PLU/EAN item in the "PLU/EAN" window, select the item and press the **[DEL]** key. A confirmation window appears to ask you whether to delete the item, select the option you prefer.

Procedure

Select a pertinent PLU code, or directly enter a PLU code or EAN code.



00001	
PRICE	0.00
TYPE	PLU00001
DEPT. CODE	PRESET
NON-ACCESS	01
PGM	NON DEL.
	01

Program each item as follows:

• PRICE (Use the numeric entry)

Unit price of each price level (max. 8 digits)

• Description (Use the character entry)

Description for a PLU/EAN. Up to 16 characters can be entered. (Default text: PLUnnnnn for (PLUs))

• TYPE (Use the selective entry)

Type of unit price entry for PLUs

INHIBIT: Inhibited
 OPEN: Open only
 PRESET: Preset only
 OPEN & PRESET: Open & preset

NOTE

For EANs, it is fixed to "PRESET".

• DEPT. CODE (Use the numeric entry)

Department code to be associated with the entered PLU/EAN (01 through 99)

When a PLU/EAN is associated with a department, the following functions of the PLU/EAN depend on the programming for the department.

- Grouping (group 1 through 12)
- Single item cash sale
- HALO (only for subdepartments)
- Taxability

• NON-ACCESS (Use the selective entry)

DEL. BY Z: Delete non-accessed EANs by Z1 report.

NON DEL.: Not delete non-accessed EANs by Z1 report.

NOTE

For PLUs, it is fixed to "NON DEL.".

■ PLU range

You can program PLUs in the designated range.

Procedure

```
PLU RANGE
START      00000
END        00000
OPERATION NEW&MAINT.
PGM                               01
```



```
00001-00010
PRICE
TYPE
DEPT. CODE
NON-ACCESS
PGM                               01
```

Enter a value or select an option for each item as follows:

- **START (Use the numeric entry)**
Starting PLU code (max. 5 digits)
- **END (Use the numeric entry)**
Ending PLU code (max. 5 digits)
- **OPERATION (Use the selective entry)**
 - DELETE: Enables you to delete a specified range of PLUs.
 - MAINT.: Enables you to change the setting you have programmed.
 - NEW&MAINT.: Enables you to change the current setting when the specified codes have already been created or to create new codes when the specified codes have not been created yet.

■ EAN Non-PLU code format

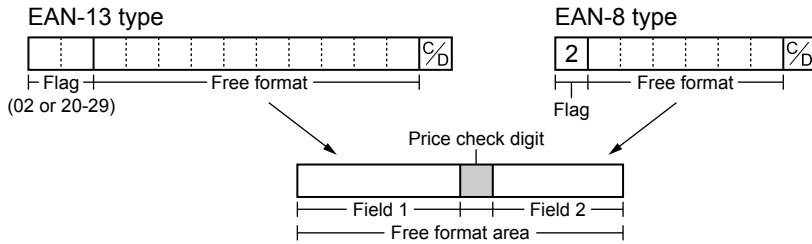

Procedure

Select an arbitrary number, or a pertinent EAN TYPE OF CODE & SYSTEM CODE you set.



```

01
TYPE OF CODE      EAN13
SYSTEM CODE       20
LENGTH FLD#1     5
LENGTH FLD#2     4
FLD#1 DATA      FREE
FLD#2 DATA      PRICE
PGM              01
    
```

The screen continues.

Program each item as follows:

NOTE To delete a code format in the "EAN NON-PLU" window, select the code format and press the **(DEL)** key. A confirmation window appears to ask you whether to delete the code format, select the option you prefer.

- **TYPE OF CODE (Use the selective entry)**
 - EAN-8: EAN-8 format code (consisting of 8 digits)
 - EAN-13 (UPC-A): EAN-13 format code (consisting of 13 digits)
- **SYSTEM CODE (Use the numeric entry)**
 - System code (i.e. flag code): EAN-8: 1 digit, EAN-13: 2 digits
- **LENGTH FLD#1 (Use the numeric entry)**
 - Length of field 1 (number of digits): 0 to 9
- **LENGTH FLD#2 (Use the numeric entry)**
 - Length of field 2 (number of digits): 0 to 9
- **FLD#1 DATA**
 - Meaning of field 1: It is fixed to FREE.
- **FLD#2 DATA (Use the selective entry)**
 - Meaning of field 2
 - PRICE: Price
 - QUANTITY: Quantity
- **CHECK DIGIT (Use the selective entry)**
 - Price check digit
 - YES: Use the price check digit
 - NO: Not use the price check digit
- **TAB (Use the selective entry)**
 - TAB or decimal point of field: 3/2/1/0

■ EAN delete

You can delete the EAN codes which have not been accessed during the period you set in this program when you execute the delete job in EAN DELETE in X1/Z1 mode.

Procedure

EAN DELETE	
PERIOD <DAY>	99
PGM	01

Program each item as follows:

- **PERIOD (DAY) (Use the numeric entry)**

Enter the EAN record delete period: 01 to 99 (00: Not delete by the non-accessed deleting job)

Functional Programming

Use the following procedure to select any option included in the functional programming group:

Procedure

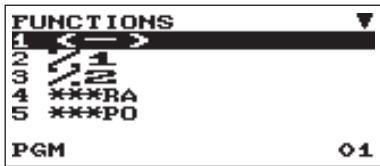
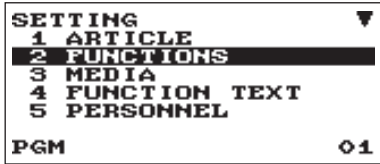

The screen continues.

1. In the SETTING window, select “2 FUNCTIONS.”
 - The FUNCTIONS window will appear.
2. Select any option from the following options list.

1 (-)	Discount
2 %1	Percent 1
3 %2	Percent 2
4 ***RA	Received on account
5 ***PO	Paid out
6 ****CID	Cash in drawer
7 CHK/CG	Check change
8 CA/CHK	Check cashing

The following illustration shows those options included in this programming group.

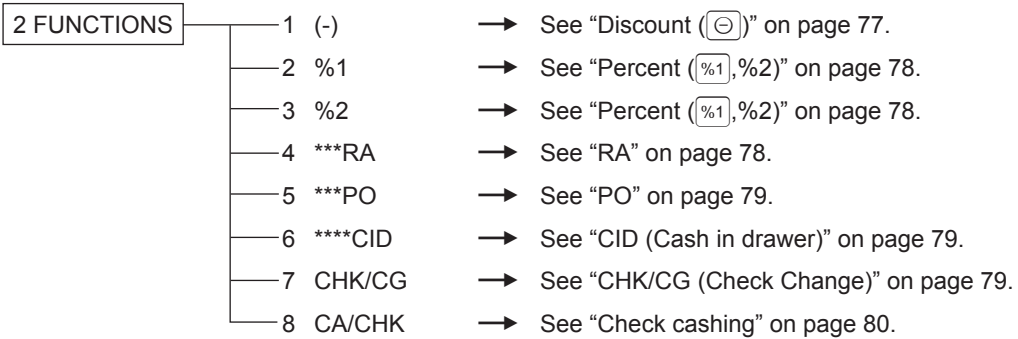

■ Discount (⊖)

Procedure

< — >	
AMOUNT	— 0 . 00
TEXT	< — >
SIGN	—
HALO	999999 . 99
ITEM	YES
SUBTOTAL	YES
PGM	01

Program each item as follows:

- **AMOUNT (Use the numeric entry)**
Discount amount (max. 8 digits)
 - **TEXT (Use the character entry)**
Description for the discount key. Up to 12 characters can be entered.
 - **SIGN (Use the selective entry)**
Programming of the + or - sign assigns the premium or discount function to each discount key.
+: Plus amount (premium)
-: Minus amount (discount)
 - **HALO (High Amount Lockout) (Use the numeric entry)**
This function is intended for prevention of accidentally entered unreasonably amounts.
Limit amount: 0.00 to 999999.99
- NOTE** *In the initial programming, the HALO function is programmed as "INVALID".*
- **ITEM (Use the selective entry)**
YES: Enables the item discount.
NO: Disables the item discount.
 - **SUBTOTAL (Used the selective entry)**
YES: Enables the subtotal discount.
NO: Disables the subtotal discount.

■ Percent (%1 , %2)

Procedure

```

// 1
RATE          -0.00%
TEXT
SIGN          / 1
HALO          100.00%
ITEM          NO
SUBTOTAL     YES
PGM          01
  
```

Program each item as follows:

- **RATE (Use the numeric entry)**
Percent rate (0.00 to 100.00)
- **TEXT (Use the character entry)**
Description for the percent key. Up to 12 characters can be entered.
- **SIGN (Use the selective entry)**
Programming of the + or - sign assigns the premium or discount function to each percent key.
+: Plus (premium)
-: Minus (discount)
- **HALO (High Amount Lockout) (Use the numeric entry)**
This function is intended for prevention of accidentally entered unreasonably amounts.
HALO (High Amount Lockout) for the percent key (0.00 to 100.00)
NOTE *In the initial programming, the HALO function is programmed as "INVALID".*
- **ITEM (Use the selective entry)**
YES: Enables the item %.
NO: Disables the item %.
- **SUBTOTAL (Used the selective entry)**
YES: Enables the subtotal %.
NO: Disables the subtotal %.

■ RA

You can program an upper limit amount and description for received-on-account key.

Procedure

```

***RA
HALO          9999999.99
TEXT          ***RA
PGM          01
  
```

Program each item as follows:

- **HALO (High Amount Lockout) (Use the numeric entry)**
This function is intended for prevention of accidentally entered unreasonably amounts.
Limit amount: 0.00 to 9999999.99
NOTE *In the initial programming, the HALO function is programmed as "INVALID".*
- **TEXT (Use the character entry)**
Description for the received-on-account key. Up to 12 characters can be entered.

■ PO

You can program an upper limit amount and description for paid-out key.

Procedure

***PO	9999999.99
HALO	***PO
TEXT	
PGM	01

Program each item as follows:

- **HALO (High Amount Lockout) (Use the numeric entry)**

This function is intended for prevention of accidentally entered unreasonably amounts.

Limit amount: 0.00 to 9999999.99

NOTE *In the initial programming, the HALO function is programmed as "INVALID".*

- **TEXT (Use the character entry)**

Description for the paid-out key. Up to 12 characters can be entered.

■ CID (Cash in drawer)

You can program the description and the upper limit amounts for cash in drawer (sentinel).

Procedure

C ID	99999999.99
HALO	***CID
TEXT	
PGM	01

Program each item as follows:

- **HALO (High Amount Lockout) (Use the numeric entry)**

This function is intended for prevention of accidentally entered unreasonably amounts.

Limit amount: 0.00 to 99999999.99

NOTE *• In the initial programming, the HALO function is programmed as "INVALID".
• When the cash in drawer amounts exceeds a limit amount, the sentinel mark (X) will be displayed.*

- **TEXT (Use the character entry)**

Description for the cash in drawer. Up to 12 characters can be entered.

■ CHK/CG (Check change)

You can program the description and the upper limit amounts for check change.

Procedure

CHK/CG	999999.99
HALO	CHK/CG
TEXT	
PGM	01

Program each item as follows:

- **HALO (High Amount Lockout) (Use the numeric entry)**

This function is intended for prevention of accidentally entered unreasonably amounts.

Limit amount: 0.00 to 999999.99

NOTE *In the initial programming, the HALO function is programmed as "INVALID".*

- **TEXT (Use the character entry)**

Description for check change. Up to 12 characters can be entered.

■ Check cashing

You can program the description and the upper limit amounts for check cashing.

Procedure

CA/CHK	999999.99
HALO	CA/CHK
TEXT	
PGM	01

Program each item as follows:

- **HALO (High Amount Lockout) (Use the numeric entry)**

This function is intended for prevention of accidentally entered unreasonably amounts.

Limit amount: 0.00 to 999999.99

NOTE *In the initial programming, the HALO function is programmed as "INVALID".*

- **TEXT (Use the character entry)**

Description for check cashing. Up to 12 characters can be entered.

Media Key Programming

Use the following procedure to select any option included in the media group:

Procedure

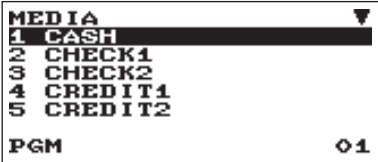
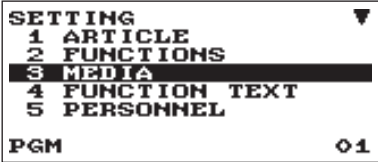

The screen continues.

1. In the SETTING window, select “3 MEDIA.”
 - The MEDIA window will appear.
2. Select any option from the following options list.

1	CASH	Cash
2	CHECK1	Check1
3	CHECK2	Check2
4	CREDIT1	Credit1
5	CREDIT2	Credit2
6	FOREIGN CURRENCY	Foreign Currency

The following illustration shows those options included in this programming group.

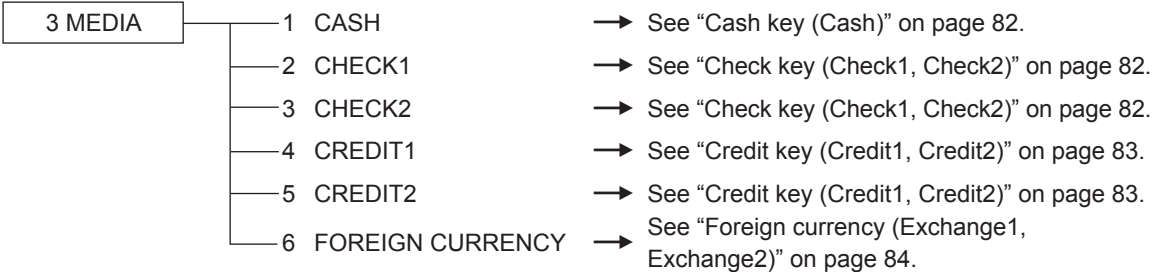

■ Cash key (Cash)

Procedure

```
CASH  
TEXT ██████████ CASH  
HALO 999999.99  
FOOTER PRINT NO  
TEND . NON-COMPUL .  
  
PGM A 01
```

Program each item as follows:

- **TEXT (Use the character entry)**
Description for the cash key. Up to 12 characters can be entered.
- **HALO (High Amount Lockout) (Use the numeric entry)**
This function is intended for prevention of accidentally entered unreasonably amounts.
Limit amount: 0.00 to 999999.99
NOTE *In the initial programming, the HALO function is programmed as "INVALID".*
- **FOOTER PRINT (Use the selective entry)**
This item decides whether or not your register should print a message at the foot of a receipt when a specified cash key is used.
YES: Enables footer printing on the receipt.
NO: Disables footer printing on the receipt.
- **TEND. (Use the selective entry)**
NON-COMPUL.: Non-compulsory amount tendered entry.
COMPULSORY: Compulsory amount tendered entry.

■ Check key (Check1, Check2)

Procedure

```
CHECK1  
TEXT ██████████ CHECK1  
HALO 999999.99  
FOOTER PRINT NO  
TEND . NON-COMPUL .  
  
PGM A 01
```

Program each item as follows:

- **TEXT (Use the character entry)**
Description for the check key. Up to 12 characters can be entered.
- **HALO (High Amount Lockout) (Use the numeric entry)**
This function is intended for prevention of accidentally entered unreasonably amounts.
Limit amount: 0.00 to 999999.99
NOTE *In the initial programming, the HALO function is programmed as "INVALID".*
- **FOOTER PRINT (Use the selective entry)**
YES: Enables footer printing on the receipt.
NO: Disables footer printing on the receipt.
- **TEND. (Use the selective entry)**
NON-COMPUL.: Non-compulsory amount tendered entry.
COMPULSORY: Compulsory amount tendered entry.

■ Credit key (Credit1, Credit2)

Procedure

```
CREDIT1
TEXT      CREDIT1
HALO      999999.99
FOOTER PRINT NO
TEND.     INHIBITED

PGM      A      01
```

Program each item as follows:

- **TEXT (Use the character entry)**

Description for the credit key. Up to 12 characters can be entered.

- **HALO (High Amount Lockout) (Use the numeric entry)**

This function is intended for prevention of accidentally entered unreasonably amounts.

Limit amount: 0.00 to 999999.99

NOTE *In the initial programming, the HALO function is programmed as "INVALID".*

- **FOOTER PRINT (Use the selective entry)**

This item decides whether or not your register should print a message at the foot of a receipt when a specified credit key is used.

YES: Enables footer printing on the receipt.

NO: Disables footer printing on the receipt.

- **TEND. (Use the selective entry)**

COMPULSORY: Compulsory amount tendered entry.

INHIBITED: Inhibits amount tendered entry.

■ Foreign currency (Exchange1, Exchange2)

Procedure

```

FOREIGN CURRENCY  ▾
PRESET RATE      ENABLE
RATE             0.000000
TEXT             EXCH1
SYMBOL
TAB              2
OPEN RATE       ENABLE
PGM              01
    
```

The screen continues.

Program each item as follows:

- **PRESET RATE (Use the selective entry)**
 ENABLE: Enables preset rate
 DISABLE: Disable preset rate
- **RATE (Use the numeric entry)**
 Currency exchange rate (0.000000 to 999.999999)
- **TEXT (Use the character entry)**
 Description for the currency exchange key. Up to 12 characters can be entered.
- **SYMBOL (Use the character entry)**
 Currency descriptor. Up to 4 characters can be entered.
- **TAB (Use the selective entry)**
 Tabulation (0 to 3)
- **OPEN RATE (Use the selective entry)**
 ENABLE: Enables open rate
 DISABLE: Disable open rate
- **TEXT (Use the character entry) for the open rate**
 Description for the currency exchange key for the open rate.
 Up to 12 characters can be entered.
- **SYMBOL (Use the character entry) for the open rate**
 Currency descriptor for the open rate. Up to 4 characters can be entered.
- **TAB (Use the selective entry) for the open rate**
 Tabulation (0 to 3) for the open rate

NOTE

Currency symbol is printed with (+) amount of foreign currency.
 The programmed character is printed at left side of amount.

EX) Case of "DM":

```

EXCH1      1.234567
           DM 1.23
    
```

↑
Programmed symbol

Function Text Programming

You can program a maximum of 12 characters for each function by using the following table:

Procedure

SETTING	▼
1 ARTICLE	
2 FUNCTIONS	
3 MEDIA	
4 FUNCTION TEXT	
5 PERSONNEL	
PGM	01



FUNCTION TEXT	▼
1 NET1	
2 DIFFER	
3 TAX1 ST	
4 TAX2 ST	
5 TAX3 ST	
PGM	01

The screen continues.

- In the SETTING window, select "4 FUNCTION TEXT".
 - The FUNCTION TEXT window will appear.

- Program each item as follows:
 - Text (Use the character entry)**
Description for each function. Up to 12 characters can be entered.

List of function text

No.	Function	Default text
1	Net 1	NET1
2	Difference	DIFFER
3	Taxable 1 subtotal	TAX1 ST
4	Taxable 2 subtotal	TAX2 ST
5	Taxable 3 subtotal	TAX3 ST
6	Taxable 4 subtotal	TAX4 ST
7	VAT/tax 1	VAT 1
8	VAT/tax 2	VAT 2
9	VAT/tax 3	VAT 3
10	VAT/tax 4	VAT 4
11	Total tax (on report)	TTL TAX
12	Net without tax (on report)	NET
13	Net 2	NET2
14	Refund	REFUND
15	Void	VOID
16	Void mode	VOID MODE
17	Manager void	MGR VOID
18	Subtotal void	SBTL VOID
19	Hash void	HASH VOID
20	Hash refund	HASH RF
21	Bill counter	BILL CNT
22	No sale	NO SALE
23	Starting cash memory (+)	SCM(+)
24	Starting cash memory (-)	SCM(-)

No.	Function	Default text
25	Guest (customer/transaction count)	GUEST
26	Paid total	PAID TL
27	Average	AVE.
28	Check payment for exchange 1	EX1 CHK
29	Credit payment for exchange 1	EX1 CR
30	Domestic currency 1	DOM.CUR1
31	Domestic currency 2	DOM.CUR2
32	Domestic currency 1 for check	DOM.CUR1 CHK
33	Domestic currency 1 for credit	DOM.CUR1 CR
34	Check in drawer	*CH ID
35	Cash/check in drawer	CA/CHK ID
36	Group 1	GROUP01
37	Group 2	GROUP02
38	Group 3	GROUP03
39	Group 4	GROUP04
40	Group 5	GROUP05
41	Group 6	GROUP06
42	Group 7	GROUP07
43	Group 8	GROUP08
44	Group 9	GROUP09
45	(+)dept. total	*DEPT TL
46	(-)dept. total	DEPT(-)
47	Hash(+) total	*HASH TL
48	Hash(-) total	HASH(-)

No.	Function	Default text
49	Cash/check is	CA/CHK IS
50	Exchange 1 is	EXCH1 IS
51	CCD difference	CCD DIF.
52	CCD difference total	DIF. TL
53	Total	***TOTAL
54	Subtotal	SUBTOTAL
55	Starting cash memory total	SCM TTL
56	CCD report title	CCD
57	Non-add code text	#
58	Sales q'ty	ITEMS
59	Merchandise subtotal	MDSE ST

No.	Function	Default text
60	Net 1 (Taxable 1 - VAT/tax 1)	NET 1
61	Net 2 (Taxable 2 - VAT/tax 2)	NET 2
62	Net 3 (Taxable 3 - VAT/tax 3)	NET 3
63	Net 4 (Taxable 4 - VAT/tax 4)	NET 4
64	(reserved)	
65	Due (on display)	DUE
66	Change	CHANGE
67	Copy receipt title	COPY
68	Guest check receipt title	BILL
69	Receipt switch	RCP SW.
70	Overlapped clerk remain	OVCS REMAIN

Personnel Programming

Use the following procedure to select any option included in the personnel group:

Procedure

```

SETTING
1 ARTICLE
2 FUNCTIONS
3 MEDIA
4 FUNCTION TEXT
5 PERSONNEL
PGM 01
    
```



```

PERSONNEL
1 CLERK
2 MANAGER
3 MODE PASS CODE
4 TRAINING CLK
PGM 01
    
```

1. In the SETTING window, select "5 PERSONNEL."
 • The PERSONNEL window will appear.

2. Select any option from the following options list.

1	CLERK	Clerk
2	MANAGER	Manager
3	MODE PASS CODE	Mode pass code
4	TRAINING CLK	Training Clerk

The following illustration shows those options included in this programming group.

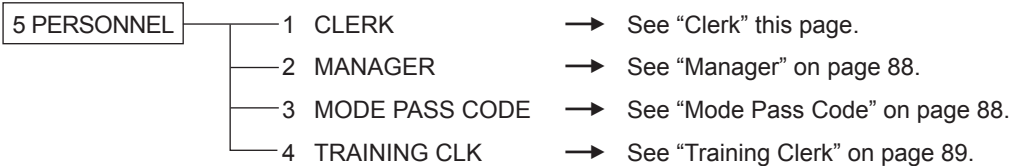

■ Clerk

Procedure

```

CLERK
01 CLERK01
02 CLERK02
03 CLERK03
04 CLERK04
PGM 01
    
```



```

01 PASS CODE          0000
AUTO KEY             CLERK01
                    ENABLE
PGM 01
    
```

Program each item as follows:

- **PASS CODE (Use the numeric entry)**
 Pass code (max. 4 digits: 0001 to 9999/0000)
- **Text (Use the character entry)**
 Description for the clerk name (Up to 16 characters can be entered.)
- **AUTO KEY (Use the selective entry)**
 ENABLE: Enables operation of the **AUTO MENU** key.
 DISABLE: Disables operation of the **AUTO MENU** key.

NOTE To delete a clerk code in the "CLERK" window, select the clerk code and press the **DEL** key. A confirmation window appears to ask you whether to delete the clerk, select the option you prefer.

■ Manager

You can program a secret code for manager.

Procedure

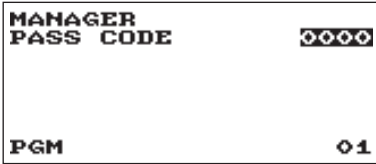

Program each item as follows:

- **PASS CODE (Use the numeric entry)**
Pass code (max. 4 digits: 0000 to 9999)

■ Mode Pass Code

You can program a secret code for each mode.

Procedure

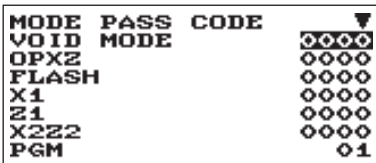

The screen continues.

Program each item as follows:

- **VOID MODE (Use the numeric entry)**
Pass code (max 4 digits: 0000 to 9999)
- **OPXZ (Use the numeric entry)**
Pass code (max 4 digits: 0000 to 9999)
- **FLASH (Use the numeric entry)**
Pass code (max 4 digits: 0000 to 9999)
- **X1 (Use the numeric entry)**
Pass code (max 4 digits: 0000 to 9999)
- **Z1 (Use the numeric entry)**
Pass code (max 4 digits: 0000 to 9999)
- **X2Z2 (Use the numeric entry)**
Pass code (max 4 digits: 0000 to 9999)
- **PGM (Use the numeric entry)**
Pass code (max 4 digits: 0000 to 9999)
- **SD CARD (Use the numeric entry)**
Pass code (max 4 digits: 0000 to 9999)

■ Training Clerk

You can set the training clerk code and text for the training mode title.

Procedure

TRAINING CLK	
CODE	00
TEXT	TRAINING
PGM	01

Program each item as follows:

- **CODE (Use the numeric entry)**
Clerk code in training (max. 2 digits: 00 to 25)
- **TEXT (Use the character entry)**
Description for the training mode title (Up to 12 characters can be entered.)

Terminal Programming

Use the following procedure to select any option included in the terminal group:

Procedure

```
SETTING ▲▼
6 TERMINAL
7 DATE/TIME
8 OPTIONAL
9 REPORT
10 MESSAGE
PGM ◊1
```



```
TERMINAL
MACHINE# 000000
CONSECUTIVE# 000000
GT2 0.00
GT3 0.00
PGM ◊1
```

1. In the SETTING windows, select "6 TERMINAL."
 - The TERMINAL windows will appear.
2. Select any option from the following options list:
 - **MACHINE# (Use the numeric entry)**
Machine number (max. 6 digits: 0 to 999999)
 - **CONSECUTIVE# (Use the numeric entry)**
Enter a number (max. 6 digits: 0 to 999999) that is the desired starting number.
 - **GT2: (Use the numeric entry)**
Enter a number (max. 13 digits: 0 to 9999999999999)
 - **GT3: (Use the numeric entry)**
Enter a number (max. 13 digits: 0 to 9999999999999)

Date/Time Setting

You can set the date and time for the register.

■ Date/time

Procedure

```
SETTING ▲▼
6 TERMINAL
7 DATE/TIME
8 OPTIONAL
9 REPORT
10 MESSAGE
PGM ○1
```



```
DATE/TIME
DATE 01/01/2011
TIME 0000
PGM ○1
```

1. In the SETTING window, select "7 DATE/TIME".
 - The DATE/TIME window will appear.
2. Set each item as follows:
 - **DATE (Use the numeric entry)**
Enter the day (2 digits), month (2 digits), and year (2 digits) in this sequence.
 - **TIME (Use the numeric entry)**
Set the time (max. 4 digits) on the 24-hour system. For example, when the time is set to 2:30 AM, enter 0230; and when it is set to 2:30 PM, enter 1430. The time will be printed and displayed.

Optional Feature Selection

Use the following procedure to select any option included in the optional group:

Procedure

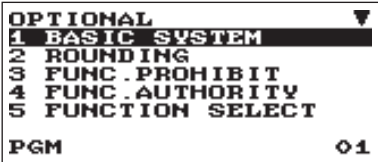

The screen continues.

1. In the SETTING window, select "8 OPTIONAL."
 - The OPTIONAL window will appear.

2. Select any option from the following options list.

1	BASIC SYSTEM	Basic system
2	ROUNDING	Rounding
3	FUNC. PROHIBIT	Function prohibited
4	FUNC. AUTHORITY	Function authority
5	FUNCTION SELECT	Function selection
6	PRINT SELECT	Print selection
7	EAN FUNCTION	EAN function
8	EXCHANGE FUNCTION	Exchange function
9	EURO CHANGE	Euro change

The following illustration shows those options included in this programming group.

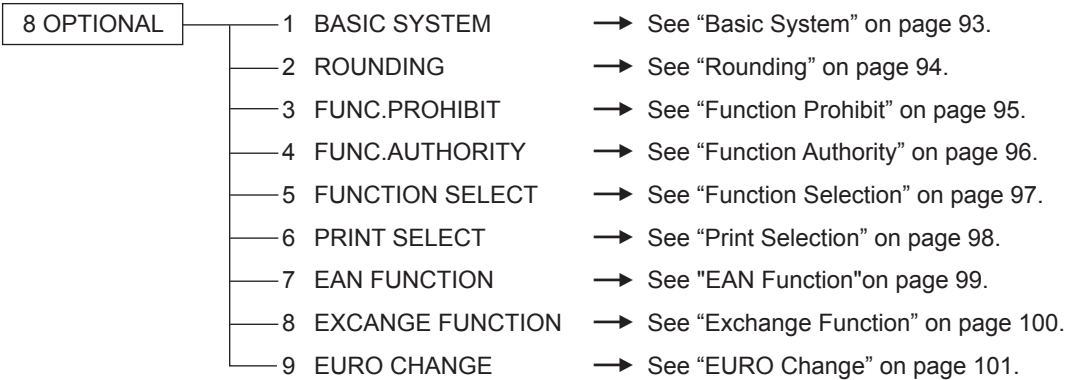

■ Basic System

Your register allows you to select various item of basic system.

Procedure

```

BASIC SYSTEM          ▼
DATE FORMAT           DMY
TIME FORMAT           24-HOUR
ERROR                 LOCK ERROR
CURRENCY SYMBOL       *
TAB                   2
DECIMAL QUANTITY     YES
PGM                   01
  
```

The screen continues.

Program each item as follows:

- **DATE FORMAT (Use the selective entry)**
 - MDY: Display and print the month, day, and year in this order
 - DMY: Display and print the day, month and year in this order
 - YMD: Display and print the year, month, and day in this order
- **TIME FORMAT (Use the selective entry)**
 - 12-HOUR: Display and print the time on 12-hour system
 - 24-HOUR: Display and print the time on 24-hour system
- **ERROR (Use the selective entry)**
 - Response to an erroneous, invalid key operation
 - LOCK ERROR: Sound a short buzzer for 2 seconds, and display Error. To hide the Error display, press the **CL** key.
 - MISS OPE.: Sound a short buzzer
- **CURRENCY SYMBOL (Use the character entry)**
 - Enter the character (Max. 4 characters)
- **TAB (Use the selective entry)**
 - 0 } Position of price delimiter can be set. Setting options are 0, 1, 2, and 3.
 - 1 } When setting to "2" for example, the entry of "100" is displayed as "1.00".
 - 2 }
 - 3 }
- **DECIMAL QUANTITY (Use the selective entry)**
 - YES: Enables the decimal quantity
 - NO: Disables the decimal quantity
- **DECIMAL ROUND (Use the selective entry)**
 - ROUND: Round off the number
 - UP: Round up after the decimal point
 - DOWN: Round down after the decimal point.
- **OVERLAPPED CLERK (Use the selective entry)**
 - YES: Enables the overlapped clerk function.
 - NO: Disables the overlapped clerk function.
- **HALO FUNC. (Use the selective entry)**
 - VALID: Valid HALO function
 - INVALID: Invalid HALO function
- **[00] KEY (Use the selective entry)**
 - [00]: Display [00] by pressing the **00** key
 - [000]: Display [000] by pressing the **00** key
- **PRT/DSP EDIT (Use the selective entry)**
 - YES: All of printing and display are edited
 - NO: All of printing and display aren't edited
- **ITEM DISPLAY (Use the selective entry)**
 - 2-LINE: The 1st line displays the quantity, price and amount. The 2nd line displays the text.
 - 1-LINE: The quantity and text.

■ Rounding

Your register allows you to select various item of rounding system.

Procedure

```
ROUNDING          ▼
ROUND100          ◊◊
ROUND10           ◊◊
ROUND FOR ITEM&TOTAL
CH/CR ROUND      YES
ROUND PRINT       NO
DIFFER MEMORY     NO
PGM               ◊1
```

The screen continues.

Program each item as follows:

• ROUND 100 (Use the selective entry)

Rounding system selection

NORMAL: Minimum rounding currency unit is 1 (1 cent)

25: Minimum rounding currency unit is 25 (25 cents)

50: Minimum rounding currency unit is 50 (50 cents)

100: Minimum rounding currency unit is 100

(ex: 1 Swedish Krona)

• ROUND 10 (Use the numeric entry)

Rounding up/down of the units digit of amount.

Enter a number (2 digits 00 to 99)

• ROUND FOR (Use the selective entry)

ITEM&TOTAL: Rounding of the item and total

TOTAL: Rounding of the total

• CH/CR ROUND (Use the selective entry)

This selection is not effective at Manual TAX1-4 system.

YES: Enable the Australian rounding

NO: Disable the Australian rounding

• ROUND PRINT (Use the selective entry)

YES: Print the rounding amount

NO: Not print the rounding amount

• DIFFER MEMORY (Use the selective entry)

YES: Memory the difference between before-rounding and after-rounding

NO: No memory the difference between before-rounding and after-rounding

• ITEM ENT (Use the selective entry)

Limit on the least significant digit in entering the amount of item

ANY: No limit at the least significant digit in each amount entry

0 ONLY: Limit to 0 at the least significant digit in each amount entry

0.5 ONLY: Limit to 0.5 at the least significant digit in each amount entry

• PAYMENT ENT (Use the selective entry)

Limit on the least significant digit in entering the amount of payment

ANY: No limit at the least significant digit in each amount entry

0 ONLY: Limit to 0 at the least significant digit in each amount entry

0.5 ONLY: Limit to 0.5 at the least significant digit in each amount entry

■ Function Prohibit

Your register allows you to select whether to enable or disable various functions.

Procedure

FUNC . PROHIBIT	ENABLE
NON-ADD	ENABLE
NON-ADD + NS	ENABLE
MINUS DEPT	ENABLE
HASH DEPT	ENABLE
COPY RCPT	ENABLE
VOID MODE	ENABLE
PGM	01

The screen continues.

Program each item as follows:

- **NON-ADD (Use the selective entry)**
 - ENABLE: Enable to enter Non-add code
 - DISABLE: Disable to enter Non-add code
- **NON-ADD + NS (Use the selective entry)**
 - ENABLE: Enable No sale after Non-add code entry
 - DISABLE: Disable No sale after Non-add code entry
- **MINUS DEPT (Use the selective entry)**
 - ENABLE: Enable to enter the minus department
 - DISABLE: Disable to enter the minus department
- **HASH DEPT (Use the selective entry)**
 - ENABLE: Enable to enter the hash department
 - DISABLE: Disable to enter the hash department
- **COPY RCPT (Use the selective entry)**
 - ENABLE: Enable the receipt copy function
 - DISABLE: Disable the receipt copy function
- **VOID MODE (Use the selective entry)**
 - ENABLE: Enable the void mode
 - DISABLE: Disable the void mode
- **SUBTOTAL<0 (Use the selective entry)**
 - ENABLE: Enable to go negative merchandise subtotal
 - DISABLE: Disable to go negative merchandise subtotal
- **TEND+DIRECT (Use the selective entry)**
 - ENABLE: Enable the direct non-tendering finalization after the previous tender entry
 - DISABLE: Disable the direct non-tendering finalization after the previous tender entry

■ Function Authority

Your register allows you to select whether to public or to limit function authority.

Procedure

FUNC . AUTHORITY	
RA	PUBLIC
PO	PUBLIC
REFUND	PUBLIC
ITEM VD	PUBLIC
SBTL VD	PUBLIC
NO SALE	PUBLIC
PGM	01

Program each item as follows:

- **RA (Use the selective entry)**
 - LIMITED: Allowed only in the Manager mode.
 - PUBLIC: Allowed in the REG mode and the Manager mode.
- **PO (Use the selective entry)**
 - LIMITED: Allowed only in the Manager mode.
 - PUBLIC: Allowed in the REG mode and the Manager mode.
- **REFUND (Use the selective entry)**
 - LIMITED: Allowed only in the Manager mode.
 - PUBLIC: Allowed in the REG mode and the Manager mode.
- **ITEM VD (Use the selective entry)**
 - LIMITED: Allowed only in the Manager mode.
 - PUBLIC: Allowed in the REG mode and the Manager mode.
- **SBTL VD (Use the selective entry)**
 - LIMITED: Allowed only in the Manager mode.
 - PUBLIC: Allowed in the REG mode and the Manager mode.
- **NO SALE (Use the selective entry)**
 - LIMITED: Allowed only in the Manager mode.
 - PUBLIC: Allowed in the REG mode and the Manager mode.

■ Function Selection

Your register enables you to select various functional selections.

Procedure

```
FUNCTION SELECT  ▼
SPLIT COUNT QUANTITY
CR IN RA/PO NON
VD MODE TO HOURLY NO
ST BEFORE DIRECT NOT
ST BEFORE TEND NOT
NS RECEIPT PRINT
PGM 01
```

The screen continues.

Program each item as follows:

- **SPLIT COUNT (Use the selective entry)**
 - Count method of split pricing entry.
 - PACKAGE: Unit of the package
 - QUANTITY: Quantity
- **CR IN RA/PO (Use the selective entry)**
 - Credit totalizer update if RA or PO finalization by the credit key.
 - NON: Not update
 - UPDATE: Update
- **VD MODE TO HOURLY (Use the selective entry)**
 - YES: Enable to add to the hourly total in void mode.
 - NO: Disable to add to the hourly total in void mode.
- **ST BEFORE DIRECT (Use the selective entry)**
 - Subtotal entry before direct non-tendering finalization
 - NOT: Not to require entry of subtotal for the non-tendering finalization
 - MUST: Require entry of subtotal for the non-tendering finalization
- **ST BEFORE TEND (Use the selective entry)**
 - Subtotal entry before tender
 - NOT: Not to require entry of subtotal for the tendering finalization
 - MUST: Require entry of subtotal for the tendering finalization
- **NS RECEIPT (Use the selective entry)**
 - Printing the receipt at the time of No Sale
 - PRINT: Print the receipt
 - NOT: Not to print the receipt
- **RCPT CONTENTS (Use the selective entry)**
 - TOTAL: Print the total only on the receipt.
 - DETAIL: Print the details on the receipt
- **AFTER TRANS. (Use the selective entry)**
 - TOTAL: Print the total only on the after transaction receipt
 - DETAIL: Print the details on the after transaction receipt
- **E.J.FULL (Use the selective entry)**
 - When the EJ file is full, whether to lock the item entry or not.
 - LOCK: Lock the item entry
 - CONTINUE: Not to lock the item entry

■ Print Selection

You can program various printing functions.

Procedure

PRINT SELECT	▼
CONSECUTIVE NO.	YES
DATE	YES
TIME	YES
PURCHASE NO.	NO
TAX STATUS	NO
TAXABLE	YES
PGM	01

The screen continues.

Program each item as follows:

- **CONSECUTIVE NO. (Use the selective entry)**
 - YES: Print the consecutive No.
 - NO: Not to print the consecutive No.
- **DATE (Use the selective entry)**
 - YES: Print the date
 - NO: Not to print the date
- **TIME (Use the selective entry)**
 - YES: Print the time
 - NO: Not to print the time
- **PURCHASE NO. (Use the selective entry)**
 - YES: Print the number of the purchase No.
 - NO: Not to print the number of the purchase No.
- **TAX STATUS (Use the selective entry)**
 - YES: Print the tax status
 - NO: Not to print the tax status
- **TAXABLE (Use the selective entry)**
 - YES: Print the taxable amount
 - NO: Not to print the taxable amount
- **TAX (Use the selective entry)**
 - YES: Print the tax amount
 - NO: Not to print the tax amount
- **TAX (TAXABLE=0) (Use the selective entry)**
 - YES: Print the tax amount (when the taxable amount is zero.)
 - NO: Not to print the tax amount (when the taxable amount is zero.)
- **TAX (TAX=0) (Use the selective entry)**
 - YES: Print the tax amount (when the tax amount is zero.)
 - NO: Not to print the tax amount (when the tax amount is zero.)
- **NET (Use the selective entry)**
 - YES: Print the NET amount
 - NO: Not to print the NET amount
- **SPLIT ENTRY (Use the selective entry)**
 - A=1st quantity, B=2nd quantity and C=unit price
 - FORMAT1: A x B/C
 - FORMAT2: A x C/B
- **ST AT ST KEY (Use the selective entry)**
 - YES: Print the subtotal using the key
 - NO: Not to print the subtotal using the key
- **LOGO FORM (Use the selective entry)**
 - PATTERN 1: 3 line text header
 - PATTERN 2: Image logo header
 - PATTERN 3: Image logo header + 3 line text footer
 - PATTERN 4: 6 line text header
 - PATTERN 5: Image logo header + 3 line text header
 - PATTERN 6: 3 line text header + 3 line text footer

- **FOOTER (Use the selective entry)**

ALL: Print the footer in any media
 BY MEDIA: Print the footer by media

- **0 AMT PLU (Use the selective entry)**

When the PLU unit price is 0, printing the amount is:
 TEXT ONLY: Print the text only
 NORMAL: Print the price and the text.

- **ITEM JOURNAL (Use the selective entry)**

ALL: Print all items on journal
 SELECT: Print the selected items on journal

- **LOGO ON JOURNAL (Use the selective entry)**

YES: Print the logo text on journal
 NO: Not to print the logo text on journal

- **BILL ON JOURNAL (Use the selective entry)**

YES: Print the bill contents on journal
 NO: Not to print the bill contents on journal

■ EAN Function

Procedure

EAN FUNCTION	
LEARNING	ENABLE
LOOKUP AT RF	YES
CODE PRINT	NO
C/D CHECK	YES
EURO CONVERT	NO
PGM	01

Program each item as follows:

- **LEARNING (Use the selective entry)**

ENABLE: Enables the EAN learning function
 DISABLE: Disables the EAN learning function

- **LOOKUP AT RF (Use the selective entry)**

YES: Enables to look up the price at refund entry of EANs
 NO: Disables to look up the price at refund entry of EANs

- **CODE PRINT (Use the selective entry)**

R&J: Print the EAN code on receipt and journal
 J: Print the EAN code on journal
 R: Print the EAN code on receipt
 NO: Not to print the EAN code

- **C/D CHECK (Use the selective entry)**

YES: Check the check digit of EAN codes at entries
 NO: Not to check the check digit

- **EURO CONVERT (Use the selective entry)**

Converting the unit price of Non-PLU code between EURO and local
 ALL: Converting for all codes
 21-23, 27: Converting for "prefix: 21, 22, 23 or 27"
 NO: Not to convert the unit price

■ Exchange Function

Procedure

```
EXCHANGE FUNCTION
PAY FOR EX1      CASH
EX1 CALC        MULTI.
TTL&CHANGE     DOMESTIC
ST SHORT TEND  PRINT

PGM                                01
```

Program each item as follows:

- **PAY FOR EX1 (Use the selective entry)**
 - Payment for the amount of Exchange 1
 - CASH: Payment is made by cash only
 - ALL: Payment is made by all media
- **EX1 CALC. (Use the selective entry)**
 - Method of the calculation for Exchange 1
 - MULTI.: Multiplication
 - DIVIDE: Division
- **TTL & CHANGE (Use the selective entry)**
 - Print the total and change for the amount of Exchange 1
 - DOMESTIC: The domestic item only
 - WITH EX1: Print the total and the change for the amount of Exchange 1
- **ST SHORT TEND (Use the selective entry)**
 - Print the subtotal after Exchange short tendering
 - NOT: Not to print the subtotal
 - PRINT: Print the subtotal

■ EURO Change

You can program optional functions for EURO change. For the details, refer to EURO Migration Function section.

Procedure

```
EURO CHANGE
DATE          000000
TIME          00
PRICE CONVERT YES
EURO JOB NON-COMPUL.
PGM          01
```

Program each item as follows:

• DATE (Use the numeric entry)

Preset the date to execute the automatic EURO modification operation.

Enter the day (2 digits), month (2 digits), and year (2 digits) in this sequence.

• TIME (Use the numeric entry)

Preset the time of the date to execute the automatic EURO modification operation.

Enter the hour (00-23)

• PRICE CONVERT (Use the selective entry)

YES: Converts the preset unit prices of Dept./PLU/EAN in the automatic EURO modification operation.

NO: Does not convert the preset unit prices of Dept./PLU/EAN to the ones of EURO currency in the automatic EURO modification operation.

NOTE *The preset rate of the Exchange 1 is applied as the conversion rate, and the calculation method is set to "division".*

• EURO JOB (Use the selective entry)

NON-COMPUL.: Non-compulsory the automatic EURO modification operation in the X2/Z2 mode after the preset date.

COMPULSORY: Compulsory the automatic EURO modification operation in the X2/Z2 mode after the preset date.

NOTE *When the EURO STATUS of your register is already "D" (i.e. the domestic currency has been changed to EURO in your register), this programming is disabled.*

Report Programming

Use the following procedure to select any option included in the report group:

Procedure

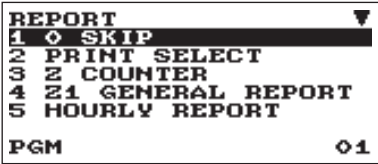
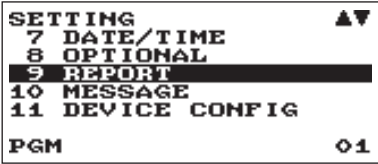

The screen continues.

1. In the SETTING window, select "9 REPORT."
 - The REPORT window will appear.

2. Select any option from the following options list:

1 0 SKIP	Zero skip
2 PRINT SELECT	Print select
3 Z COUNTER	Z counter
4 Z1 GENERAL REPORT	Z1 General report
5 HOURLY REPORT	Hourly report
6 JOURNAL	Journal data
7 CCD	CCD function

The following illustration shows those options included in this programming group.

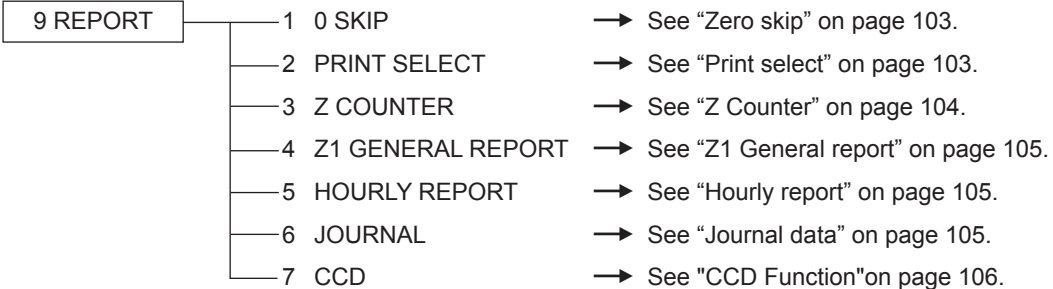

■ Zero skip

You can program whether or not to skip "0" in each report.

Procedure

```

O SKIP
DEPARTMENT      SKIP
TRANSACTION     SKIP
PLU             SKIP
CLERK          SKIP
HOURLY         SKIP
DAILY NET      SKIP
PGM            01
  
```

Program each item as follows:

- **DEPARTMENT (Use the selective entry)**
 - SKIP: Skips those data that are "0" in the department report.
 - NOT SKIP: Does not skip those data that are "0" in the department report.
- **TRANSACTION (Use the selective entry)**
 - SKIP: Skips those data that are "0" in the transaction report.
 - NOT SKIP: Does not skip those data that are "0" in the transaction report.

- **PLU (Use the selective entry)**
 - SKIP: Skips those data that are "0" in the PLU/EAN report.
 - NOT SKIP: Does not skip those data that are "0" in the PLU/EAN report.
- **CLERK (Use the selective entry)**
 - SKIP: Skips those data that are "0" in the clerk report.
 - NOT SKIP: Does not skip those data that are "0" in the clerk report.
- **HOURLY (Use the selective entry)**
 - SKIP: Skips those data that are "0" in the hourly report.
 - NOT SKIP: Does not skip those data that are "0" in the hourly report.
- **DAILY NET (Use the selective entry)**
 - SKIP: Skips those data that are "0" in the daily net report.
 - NOT SKIP: Does not skip those data that are "0" in the daily net report.

■ Print select

You can program whether or not to print the item on the report.

Procedure

```

PRINT SELECT
SEPARATOR LINE  YES
Z COUNTER       YES
GT1 ON Z        YES
GT2 ON Z        YES
GT3 ON Z        YES
TR GT ON Z      YES
PGM            01
  
```

The screen continues.

Program each item as follows:

- **SEPARATOR LINE (Use the selective entry)**
 - YES: Print the separate line on the report.
 - NO: Not to print the separate line on the report.
- **Z COUNTER (Use the selective entry)**
 - YES: Print the Z counter on the Z report.
 - NO: Not to print the Z counter on the Z report.
- **GT1 ON Z (Use the selective entry)**
 - YES: Print GT1 on the Z report.
 - NO: Not to print GT1 on the Z report.
- **GT2 ON Z (Use the selective entry)**
 - YES: Print GT2 on the Z report.
 - NO: Not to print GT2 on the Z report.
- **GT3 ON Z (Use the selective entry)**
 - YES: Print GT3 on the Z report.
 - NO: Not to print GT3 on the Z report.
- **TR GT ON Z (Use the selective entry)**
 - YES: Print the training GT on the Z report.
 - NO: Not to print the training GT on the Z report.

- **GT1 ON X (Use the selective entry)**
 YES: Print GT1 on the X report.
 NO: Not to print GT1 on the X report.
- **GT2 ON X (Use the selective entry)**
 YES: Print GT2 on the X report.
 NO: Not to print GT2 on the X report.
- **GT3 ON X (Use the selective entry)**
 YES: Print GT3 on the X report.
 NO: Not to print GT3 on the X report.
- **TR GT ON X (Use the selective entry)**
 YES: Print the training GT on the X report.
 NO: Not to print the training GT on the X report.
- **VD MODE ON X1Z1 (Use the selective entry)**
 YES: Print total of VOID MODE on X1Z1 report
 NO: Not to print total of VOID MODE on X1Z1 report
- **VD MODE ON X2Z2 (Use the selective entry)**
 YES: Print total of VOID MODE on X2Z2 report
 NO: Not to print total of VOID MODE on X2Z2 report
- **PLU/EAN DATA ON Z (Use the selective entry)**
 YES: Print PLU/EAN data on the PLU/EAN Z report.
 NO: Not to print PLU/EAN data on the PLU/EAN Z report.
- **EJ DATA ON Z (Use the selective entry)**
 YES: Print EJ data on the EJ Z report.
 NO: Not to print EJ data on the EJ Z report.
- **JOURNAL SIZE (Use the selective entry)**
 SMALL: Print journal in a small size.
 NORMAL: Print journal in a normal size.

■ Z Counter

Procedure

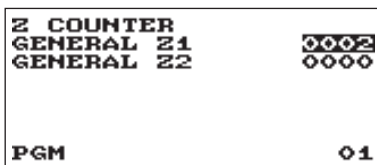

GENERAL Z1: Max.4 digits (0000 to 9999)

GENERAL Z2: Max.4 digits (0000 to 9999)

■ Z1 General report

Procedure

```
Z1 GENERAL REPORT
SD: SAVE SALES      NO
SD: SAVE EJ        NO
SD: SAVE ALL RAM   NO
CLEAR EJ          NO
RESET GT          NO
PGM                01
```

• CLEAR EJ (Use the selective entry)

YES: Clear the electronic journal data

NO: Not to clear the electronic journal data

• RESET GT (Use the selective entry)

YES: Reset the GT

NO: Not to reset the GT

• SD: SAVE SALES (Use the selective entry)

YES: Save the sales data in the SD card.

NO: Not to save the sales data in the SD card.

• SD: SAVE EJ (Use the selective entry)

YES: Save the electronic journal data in the SD card.

NO: Not to save the electronic journal data in the SD card.

• SD: SAVE ALL RAM (Use the selective entry)

YES: Save the all RAM data in the SD card.

NO: Not to save the all RAM data in the SD card.

■ Hourly report

You can program the memory type and the starting time for the hourly report.

Procedure

```
HOURLY REPORT
MEMORY TYPE      30MIN
START TIME       00
PGM                01
```

Program each item as follows:

• MEMORY TYPE (Use the selective entry)

30MIN: Selects the 30-minute type.

60MIN: Selects the 60-minute type.

• START TIME (Use the numeric entry)

Starting time entry (max. 2 digits: 0 to 23)

■ Journal data

Procedure

```
JOURNAL
STORE TO SD     W SPACE
TR DATA STORE  YES
X DATA STORE   HEADER
PGM                01
```

• STORE TO SD (Use the selective entry)

When the EJ data is recorded on the SD card:

AS IS: Control characters are recorded as they are

W SPACE: Control characters are recorded as space.

• TR DATA STORE (Use the selective entry)

YES: Record the journal data in the training mode.

NO: Not to record the journal data in the training mode.

• X DATA STORE (Use the selective entry)

When the X report data in the journal is recorded:

HEADER: Record only the header of X report in the journal

DETAIL: Record the detail of X report in the journal

■ CCD Function

Procedure

CCD					
CCD					NO
LOCK	OF	REG			NO
LOCK	OF	X			YES
PGM					01

Program each item as follows:

- **CCD (Use the selective entry)**

Compulsion of the CCD entry

NO: Non compulsory

FOR IND. CLERK: Compulsory for IND. Clerk report operation

FOR ALL CLERK: Compulsory for ALL Clerk report operation

- **LOCK OF REG (Use the selective entry)**

YES: Lock the REG mode entry after IND. Clerk resetting (Z)

NO: Not to lock the REG mode entry

- **LOCK OF X (Use the selective entry)**

YES: Enables the reading (X) report before CCD entry

NO: Disables the reading (X) report before CCD entry

Message Programming

Use the following procedure to select any option included in the message group:

Procedure

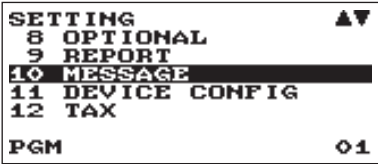

1. In the SETTING window, select “10 MESSAGE.”
 - The MESSAGE window will appear.

2. Select any option from the following options list:

1 RECEIPT LOGO Receipt logo

The following illustration shows those options included in this programming group.



■ Receipt logo

Your register can print programmed messages for customers on every receipt. The logo text is printed in a centering form on the receipt.

Procedure



Program each item as follows:

- **RECEIPT LOGO (Use the character entry)**
 Logo text for the receipt (max. 30 characters x 6 lines)

NOTE The programmable number of lines for a message varies according to the following message types:

- PATTERN 1: 3 line text header
- PATTERN 2: Image logo header
- PATTERN 3: Image logo header + 3 line text footer
- PATTERN 4: 6 line text header
- PATTERN 5: Image logo header + 3 line text header
- PATTERN 6: 3 line text header + 3 line text footer

Device Configuration Programming

Use the following procedure to select a device configuration programming:

Procedure



1. In the SETTING window, select “11 DEVICE CONFIG.”
 - The DEVICE CONFIG window will appear.
2. Select any option from the following options list:

1	KEYBOARD	Keyboard
2	DISPLAY	Display
3	PRINTER	Printer
4	RS PORT	RS port
5	ONLINE	Online
6	SCANNER	Scanner

The following illustration shows those options included in this programming group.

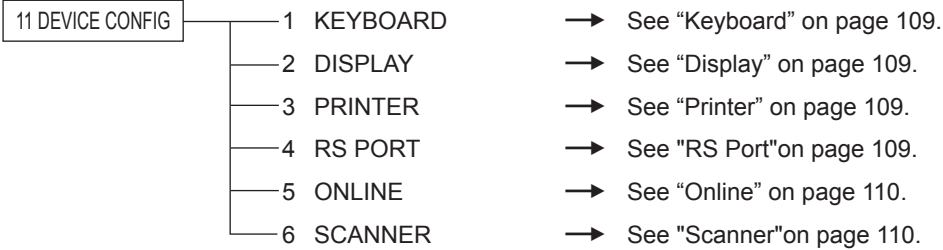

■ Keyboard

Procedure

KEYBOARD BUFFERING TOUCH SOUND	YES YES
PGM	01

Program each item as follows:

- **BUFFERING (Use the selective entry)**
YES: Enables the buffering keyboard.
NO: Disables the buffering keyboard.
- **TOUCH SOUND (Use the selective entry)**
YES: Set to sound
NO: Not to sound

■ Display

Procedure

DISPLAY POWER SAVE P.SAVE AT TM	02 YES
PGM	01

Program each item as follows:

- **POWER SAVE (Use the numeric entry)**
Time of the power save (2 digits: 0,1 to 99 minutes
0:100minutes)
- **P. SAVE AT TM (Use the selective entry)**
Power saving during time display:
YES: Enables power saving during time display
NO: Disables power saving during time display

■ Printer

Procedure

PRINTER DENSITY	30
PGM	01

Program each item as follows:

- **DENSITY (Use the numeric entry)**
Select a density level (2 digits: 00 to 99)
00: 89% for standard
50: 100% for standard
99: 111% for standard

■ RS Port

Procedure

RS PORT USE	SCANNER
PGM	01

Program each item as follows:

- **USE (Use the selective entry)**
ONLINE: RS port is used for on-line.
SCANNER: RS port is used for scanner.

■ Online

Procedure

```
ONLINE
TERMINAL No. 0000001
CI SIGNAL    NON
LINE FORM    FULL
BAUD RATE    19200
START CODE   002
END CODE     013
PGM          01
```

The screen continues.

Program each item as follows:

- **TERMINAL No. (Use the numeric entry)**
Terminal number (6 digits: 0 to 999999).
- **CI SIGNAL (Use the selective entry)**
Sensing of the CI signal
NON: Disables sensing of the CI signal
SENSING: Enables sensing of the CI signal
- **LINE FORM (Use the selective entry)**
Programming of the modem control
FULL: Full duplex system
HALF: Half duplex system

- **BAUD RATE (Use the selective entry)**
Transmission data rate
38400 bps 19200 bps
9600 bps 4800 bps
- **START CODE (Use the numeric entry)**
Start code (3 digits: 0 to 127)
- **END CODE (Use the numeric entry)**
End code (3 digits: 0 to 127)
- **TIME OUT (Use the numeric entry)**
Programming of the time-out time (3 digits: 1 to 255 sec.)

■ Scanner

Procedure

```
SCANNER
TYPE RS-CD CONTROL
BAUD RATE 4800
DATA BIT 7 bits
PARITY ODD
STOP BIT 1 bit
ITF14 W LENGTH
PGM 01
```

Program each item as follows:

- **TYPE (Use the selective entry)**
Selection of the scanner type
RS-CS CONTROL
RS-CD CONTROL
- **BAUD RATE (Use the selective entry)**
Transmission data rate
19200 bps 9600 bps 4800 bps

- **DATA BIT (Use the selective entry)**
Selection of the data bit
7 bits 8 bits
- **PARITY (Use the selective entry)**
Selection of the parity bit
NON ODD EVEN
- **STOP BIT (Use the selective entry)**
Selection of the stop bit
1 bit 2 bits
- **ITF14 (Use the selective entry)**
W LENGTH: With length
W/O LENGTH: Without length

Tax Programming

Use the following procedure to select any option included in the tax group:

Procedure

```

SETTING          ▲
 9 REPORT
10 MESSAGE
11 DEVICE CONFIG
12 TAX
13 AUTO KEY
PGM              01
    
```



```

TAX
1 TAX SYSTEM
2 TAX1
3 TAX2
4 TAX3
5 TAX4
PGM              01
    
```

1. In the SETTING window, select "12 TAX."
 - The TAX window will appear.

2. Select any option from the following options list:

1	TAX SYSTEM	Tax system
2	TAX1	Tax1
3	TAX2	Tax2
4	TAX3	Tax3
5	TAX4	Tax4

■ Tax system

Procedure

```

TAX SYSTEM
          AUTO VAT1-4
PGM              01
    
```

• Tax system (Use the selective entry)

Selection of the tax system

- AUTO TAX 1-4
- AUTO VAT 1-4
- MANUAL VAT 1-4
- MANUAL VAT 1
- MANUAL TAX 1-4
- VAT1 & TAX 2-4

■ Tax 1 through 4

Procedure

```

TAX1
TAX RATE      0.0000%
RATE SIGN     +
LOWER TAX     0.00
PGM              01
    
```

Program each item as follows:

• TAX RATE (Use the numeric entry)

Tax rate (max. 7 digits: 0.0000 to 999.9999%)

• RATE SIGN (Use the selective entry)

+: Plus rate

-: Minus rate

- This option is not available in the VAT system.

• LOWER TAX (Use the numeric entry)

Lowest taxable amount (max. 5 digits: 0.00 to 999.99)

- This option is not available in the VAT system.

Automatic Sequencing Key Programming

If you program frequently performed key operations for the AUTO keys, you can enter those key operations simply by pressing the corresponding AUTO keys in key operations.

■ Key Text

Procedure

```
SETTING ▲
 9 REPORT
10 MESSAGE
11 DEVICE CONFIG
12 TAX
13 AUTO KEY
PGM 01
```



```
AUTO KEY
1 KEY TEXT
2 KEY SEQUENCE
PGM 01
```



```
KEY TEXT
1 AUTO 1
2 AUTO 2
3 AUTO 3
4 AUTO 4
5 AUTO 5
PGM 01
```



```
AUTO 1
TEXT 1 AUTO 1
PGM A 01
```

1. In the SETTING window, select "13 AUTO KEY."
 - The AUTO KEY window will appear.

2. Select "1 KEY TEXT" by the **TL/NS** key.

3. Select the pertinent Auto key from the key list by the **TL/NS** key.

4. Enter the title of the operation for the key sequence to allocate.

TEXT: up to 12 digits

■ Key Sequence

Procedure

```

SETTING          ▲
 9 REPORT
10 MESSAGE
11 DEVICE CONFIG
12 TAX
13 AUTO KEY
PGM              01
  
```



```

AUTO KEY
1 KEY TEXT
2 KEY SEQUENCE
PGM              01
  
```



```

KEY SEQUENCE
1 AUTO 1
2 AUTO 2
3 AUTO 3
4 AUTO 4
5 AUTO 5
PGM              01
  
```



```

AUTO 1
PGM              01
  
```

1. In the SETTING window, select “13 AUTO KEY.”
 - The AUTO KEY window will appear.
2. Select “2 KEY SEQUENCE” by the TL/NS key.
3. Select the pertinent Auto key from the key list by the TL/NS key.
4. Enter the key operation sequence by any key except the AUTO MENU key.
The register allows to program up to 25 keys for each AUTO key.
5. To terminate the procedure enter the AUTO MENU key, the confirmation window will appear for sequence data saving. Select “SAVE” or “ABANDON” and enter the TL/NS key.

Example

In case of the X1 General report printing.

```

AUTO 1
 2 4 KEY
 3 TL/NS
 4 2 KEY
 5 TL/NS
 6 1 KEY
PGM              01
  
```

Key operation

```

MODE
4=(select X1/Z1 MODE)
TL/NS
2=(select READING)
TL/NS
1=(select GENERAL)
AUTO MENU TL/NS
  
```

Reading of Stored Programs

You can read programs stored in the PGM mode.

■ Program reading sequence

To read those programs stored in the PGM mode, use the following procedure:

1. Select the PGM mode from the mode selection window.
2. Select "1 READING" from the PGM mode to display the items list, and press the **TL/NS** key. Select an item listed in the table shown later.

Item:	Description:
1 DEPARTMENT	Department
2 PLU/EAN	PLU/EAN
1 RANGE	(Full or specified range) *
2 PICK UP	(By picking list) *
3 EAN OTHERS	EAN delete, Non-PLU
3 FUNCTIONS	Function
4 MEDIA	Media
5 FUNCTION TEXT	Function Text
6 CLERK	Clerk
7 MANAGER	Manager
8 MODE PASS CODE	Mode pass code
9 TRAINING CLK	Training clerk
10 OPTIONAL	Optional
11 REPORT	Report
12 MESSAGE	Message
13 DEVICE CONFIG	Device config.
14 TAX	Tax
15 AUTO KEY	Auto key
16 ROM VERSION	ROM version

* The procedure to specify a range or to pick up codes are same as the one in sales report.

■ Sample printouts

• Departments

Operating mode		*PGM*		Tax status	
Report type	DEPARTMENT				
Dept. code	D01		0.00		Unit price
Description	DPT.01	T1	01		Function programming
Group no.	G01	L999999.99		01	Amount entry type (0:Inhibit 1:Open 2:Preset 3:Open&Preset)
	D02		0.00		SICS (0:No 1:Yes)
	DPT.98				HALO limit
	G01	L999999.99			
	D99		0.00		
	DPT.99	T1	01		
	G01	L999999.99			

• PLU/EAN

Report type		*PGM*		Associated dept code	
PLU code	PLU/EAN				Amount Entry type
Description	P00001 (01)	2			Unit price
	PLU00001	125.20			
	P00002 (02)	2			
	PLU00002	5.10			
	P00003 (02)	2			
	PLU00003	1.10			
	P00004 (01)	2			
EAN code	Materials-1	1.20			Unit price
Description	4901991641585#(01)	1.00			
	Materials-2	3.10			
	5012345678900#(01)				
	Item-A	3.10			
	5045678901230#(01)	*			Non-accessed EAN delete method
	Item-B	2.20			(*: Non-delete Space: Delete in the Z1 operation)
	5087654321106#(02)				
	Goods-A	5.30			
	5099887654302#(05)				
	DPT.05	2.60			

NOTE EAN code are printed out in the sequence shown below.

EAN-13
EAN-8
UPC-A
UPC-E
ITF-14

• EAN others

PGM	
EAN OTHERS	Report type
EAN NON-PLU	Non-PLU format setting
20	Programming data (540012)
02	System code
EAN DELETE	Delete period
5 4 0 0 1 2	TAB or Decimal point of field 2 (3/2/1/0)
4 5 0 0 1 2	Price check digit (0:No, 1:Yes)
	Meaning of field 2 (0:Price, 1:Quantity)
	Meaning of field 1 (0:Free)
	Length of field 2
	Length of field 1
99	

• Functions

PGM	
FUNCTIONS	Report type
(-)	Sign (plus/minus)
IS	Function text
%1	Type I=Item S=Subtotal
S	Rate
%2	Rate
I	Rate
***RA	HALO limit
***PO	HALO limit
****CID	HALO limit
CHK/CG	HALO limit
CA/CHK	HALO limit
-0.00	
L2.00	
-0.00%	
L100.00%	
-0.00%	
L100.00%	
L9999999.99	
L9999999.99	
L99999999.99	
L999999.99	
L999999.99	

• Media

PGM	
MEDIA	Report type
	HALO
CASH	Function text
CHECK1	Function text
CHECK2	Function text
CREDIT1	Function text
CREDIT2	Function text
PRESET RATE	ENABLE
EXCH1	Tab
OPEN RATE	ENABLE
EXCH2	Rate
L999999.99 00	Programming data (00)
L999999.99 00	Entry of amount tendered (0:Non-Compulsory, 1:Compulsory)
L999999.99 00	Entry of amount tendered (0:Non-Compulsory, 1:Compulsory)
L999999.99 00	Entry of amount tendered (0:Non-Compulsory, 1:Compulsory)
L999999.99 00	Entry of amount tendered (0:Non-Compulsory, 1:Compulsory)
ENABLE	Footer print on receipt (0:No, 1:Yes)
1.550220 2	Entry of amount tendered (0:Inhibit, 1:Compulsory)
ENABLE	Footer print on receipt (0:No, 1:Yes)
2	Footer print on receipt (0:No, 1:Yes)

• Function text

PGM		
FUNCTION TEXT		Report type
		Function
		Text
NET 1	NET 1	
DIFFER	DIFFER	
TAX1 ST	TAX1 ST	
TAX2 ST	TAX2 ST	
TAX3 ST	TAX3 ST	
TAX4 ST	TAX4 ST	
VAT 1	VAT 1	
VAT 2	VAT 2	
VAT 3	VAT 3	
VAT 4	VAT 4	
TTL TAX	TTL TAX	
NET	NET	
NET2	NET2	
REFUND	REFUND	
VOID	VOID	
VOID MODE	VOID MODE	
MGR VOID	MGR VOID	
SBTL VOID	SBTL VOID	
HASH VOID	HASH VOID	
HASH RF	HASH RF	
BILL CNT	BILL CNT	
NO SALE	NO SALE	
SCM(+)	SCM(+)	
SCM(-)	SCM(-)	
GUEST	GUEST	
PAID TL	PAID TL	
AVE.	AVE.	
EX1 CHK	EX1 CHK	
EX1 CR	EX1 CR	
DOM. CUR1	DOM. CUR1	
DOM. CUR2	DOM. CUR2	
DOM. CUR1 CHK	DOM. CUR1 CHK	
DOM. CUR1 CR	DOM. CUR1 CR	

*CH ID	*CH ID
CA/CHK ID	CA/CHK ID
GROUP01	GROUP01
GROUP02	GROUP02
GROUP03	GROUP03
GROUP04	GROUP04
GROUP05	GROUP05
GROUP06	GROUP06
GROUP07	GROUP07
GROUP08	GROUP08
GROUP09	GROUP09
*DEPT TL	*DEPT TL
DEPT (-)	DEPT (-)
*HASH TL	*HASH TL
HASH (-)	HASH (-)
***TOTAL	***TOTAL
SUBTOTAL	SUBTOTAL
SCM TTL	SCM TTL
#	#
ITEMS	ITEMS
MDSE ST	MDSE ST
NET 1	NET 1
NET 2	NET 2
NET 3	NET 3
NET 4	NET 4
DUE	DUE
CHANGE	CHANGE
COPY	COPY
BILL	BILL
RCP SW.	RCP SW.
OVCS REMAIN	OVCS REMAIN

• Clerk

PGM	
CLERK	
CLK#01	CLERK01 0 0000
CLK#02	CLERK02 0 0000
CLK#03	CLERK03 0 0000
CLK#25	CLERK25 0 0000

Report type
Clerk code
Clerk name
Auto key operation/Pass code
(0: Enable)
(1: Disable)

• Manager

PGM	
MANAGER	
PASS CODE	9999

Report type
Pass code

• Mode pass code

PGM	
MODE PASS CODE	
VOID MODE	1111
OPXZ	0000
FLASH	0000
X1	0000
Z1	0000
X2Z2	0000
PGM	1234
SD CARD	7777

Report type
Mode
Pass code

• Training clerk

PGM	
TRAINING CLK	
CODE	00
TEXT	TRAINING

Report type
Training clerk code
Training mode title text

• Optional

PGM		Report type
OPTIONAL		
BASIC SYSTEM		Item
DATE FORMAT	DMY	
TIME FORMAT	24-HOUR	Setting
ERROR	LOCK ERROR	
CURRENCY SYMBOL	*	
TAB	2	
DECIMAL QUANTITY	YES	
DECIMAL ROUND	ROUND	
OVERLAPPED CLERK	YES	
HALO FUNC.	INVALID	
{00}KEY	{00}	
PRT/DSP EDIT	YES	
ITEM DISPLAY	2-LINE	
ROUNDING		
ROUND100	NORMAL	
ROUND10	00	
ROUND FOR	ITEM&TOTAL	
CH/CR ROUND	YES	
ROUND PRINT	NO	
DIFFER MEMORY	NO	
ITEM ENT	ANY	
PAYMENT ENT	ANY	
FUNC. PROHIBIT		
NON-ADD	ENABLE	
NON-ADD + NS	ENABLE	
MINUS DEPT	ENABLE	
HASH DEPT	ENABLE	
COPY RCPT	ENABLE	
VOID MODE	ENABLE	
SUBTOTAL<0	ENABLE	
TEND+DIRECT	ENABLE	
FUNC. AUTHORITY		
RA	PUBLIC	
PO	PUBLIC	
REFUND	PUBLIC	
ITEM VD	PUBLIC	
SBTL VD	PUBLIC	
NO SALE	PUBLIC	
FUNCTION SELECT		
SPLIT COUNT	QUANTITY	
CR IN RA/PO	NON	
VD MODE TO HOURLY	NO	
ST BEFORE DIRECT	NOT	
ST BEFORE TEND	NOT	
NS RECEIPT	PRINT	
RCPT CONTENTS	DETAIL	
AFTER TRANS.	DETAIL	
E. J. FULL	CONTINUE	

PRINT SELECT	
CONSECUTIVE NO.	YES
DATE	YES
TIME	YES
PURCHASE NO.	NO
TAX STATUS	NO
TAXABLE	YES
TAX	YES
TAX(TAXABLE=0)	NO
TAX(TAX=0)	NO
NET	YES
SPLIT ENTRY	FORMAT1
ST AT ST KEY	NO
LOGO FORM	PATTERN1
FOOTER	BY MEDIA
O AMT PLU	TEXT ONLY
ITEM JOURNAL	ALL
LOGO ON JOURNAL	NO
BILL ON JOURNAL	NO
EAN FUNCTION	
LEARNING	ENABLE
LOOKUP AT RF	YES
CODE PRINT	NO
C/D CHECK	YES
EURO CONVERT	NO
EXCHANGE FUNCTION	
PAY FOR EX1	CASH
EX1 CALC.	MULTI.
TTL&CHANGE	DOMESTIC
ST SHORT TEND	PRINT
EURO CHANGE	
DATE	00/00/2000
TIME	00
PRICE CONVERT	YES
EURO JOB	NON-COMPUL.

• Report

PGM	
REPORT	
0 SKIP	
DEPARTMENT	SKIP
TRANSACTION	SKIP
PLU	SKIP
CLERK	SKIP
HOURLY	SKIP
DAILY NET	SKIP
PRINT SELECT	
SEPARATOR LINE	YES
Z COUNTER	YES
GT1 ON Z	YES
GT2 ON Z	YES
GT3 ON Z	YES
TR GT ON Z	YES
GT1 ON X	NO
GT2 ON X	NO
GT3 ON X	NO
TR GT ON X	NO
VD MODE ON X1Z1	YES
VD MODE ON X2Z2	YES
PLU/EAN DATA ON Z	YES
EJ DATA ON Z	YES
JOURNAL SIZE	SMALL

Report type

Setting

Item

Z COUNTER	
GENERAL Z1	0002
GENERAL Z2	0000
Z1 GENERAL REPORT	
SD: SAVE SALES	NO
SD: SAVE EJ	NO
SD: SAVE ALL RAM	NO
CLEAR EJ	NO
RESET GT	NO
HOURLY REPORT	
MEMORY TYPE	30MIN
START TIME	00
JOURNAL	
STORE TO SD	W SPACE
TR DATA STORE	YES
X DATA STORE	HEADER
CCD	
CCD	NO
LOCK OF REG	NO
LOCK OF X	YES

• Message

PGM	
MESSAGE	
RECEIPT LOGO	
THANK YOU	
FOR YOUR	
PURCHASE	
WE ARE LOOKING	
FORWARD TO	
YOUR NEXT VISIT	

Report type

Receipt logo text

• Device configuration

PGM	
DEVICE CONFIG	
KEYBOARD BUFFERING	YES
TOUCH SOUND	NO
DISPLAY	
POWER SAVE	2
P. SAVE AT TM	YES
PRINTER DENSITY	50
RS PORT USE	SCANNER
SCANNER TYPE	RS-CD CONTROL
BAUD RATE	4800
DATA BIT	7 bits
PARITY	ODD
STOP BIT	1 bit
ITF14	W LENGTH
ONLINE TERMINAL No.	000001
CI SIGNAL	NON
LINE FORM	FULL
BAUD RATE	19200
START CODE	002
END CODE	013
TIME OUT	007

Report type

Setting

Item

• Tax rate

PGM	
TAX	
TAX SYSTEM	AUTO TAX1-4
TAX1	1. 0000 %
	0. 01
TAX2	2. 0000 %
	0. 02
TAX3	3. 0000 %
	0. 03
TAX4	4. 0000 %
	0. 04

Report type

Tax no.

Tax system

Rate

Lower taxable amount

• AUTO key

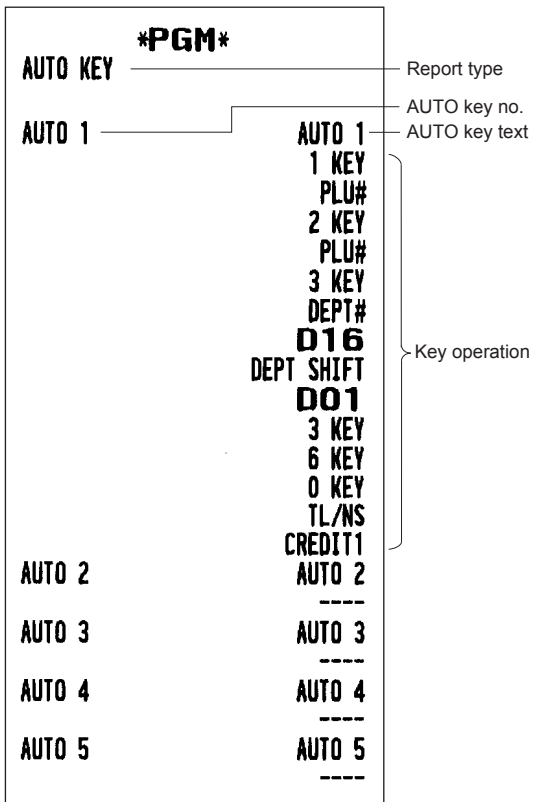

• ROM version

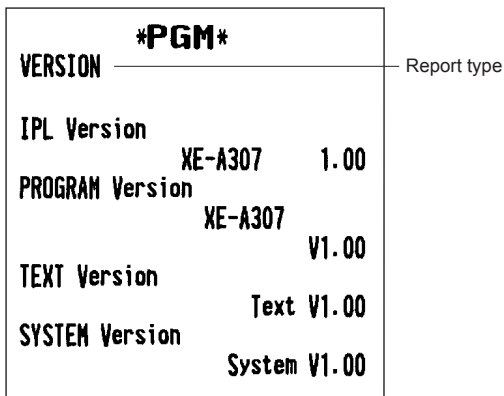

SD CARD Mode

The register's data can be saved to the SD memory card, and the programming data can be loaded from the SD memory card.

To use the SD card function, select the "7 SD CARD MODE" mode in the mode selection window and perform the following operations.

■ Inserting and removing an SD memory card

The SD card slot is located on the front side of your register.

Inserting an SD memory card

Insert an SD memory card into the SD card slot with the printed SD logo facing upwards. Push the card in steady with a finger until it clicks and release it slowly.

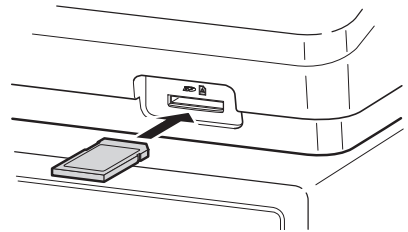

Removing the SD memory card

Push the card in gently with a finger and release it. The card will come out.

NOTE

- This model supports SD cards only. Use of any other types of SD cards such as mini SD, micro SD, etc. with an adapter is not supported.
- When inserting or removing the SD memory card, be sure to release it slowly. Otherwise, the card may pop out and injure your finger.
- Never touch or remove the SD memory card while it is accessed, otherwise the data stored in it may be damaged.
- Formatting the SD memory card erases all the data in it.

CAUTION: Never turn the power off, while the SD memory card is accessed.

■ SD card formatting

When the SD card is not formatted yet, take the formatting operation.

Procedure

- (1) Select "4 FORMATTING" in the SD CARD mode, the confirmation window is displayed.
- (2) To perform the format operation, select OK and press the **[TL/NS]** key.
To cancel the operation, select CANCEL and press the **[TL/NS]** key.

■ Folder creating

The master folder can be created for the data file.

(¥ SHARP¥ ECRXXX12¥ nnnnnnnn¥ : nnnnnnnn/folder name)

Procedure

- (1) Select "3 FOLDER CONTROL" in the SD CARD mode and press the **[TL/NS]** key.
- (2) Select "1 CREATE FOLDER", the folder name entry window is displayed.
- (3) Enter the required folder name and press the **[TL/NS]** key.
To cancel the operation, press the **[ESC/CANCEL]** key.

■ Folder name selecting

Procedure

- (1) Select "3 FOLDER CONTROL" in the SD CARD mode and press the **[TL/NS]** key, the FOLDER CONTROL window is displayed.
- (2) Select "2 SELECT FOLDER", the folder name list window is displayed.
- (3) Select the required folder name from the list, and press the **[TL/NS]** key.
To cancel the operation, press the **[ESC/CANCEL]** key.

■ Data saving

The sales data, EJ data, data or programming data can be saved to the SD card.

Procedure

(1) Select "1 SAVING" in the SD CARD mode, the selection window "SAVE" or "SAVE FOR ONLINE" is displayed.

1. SAVE: Saves data

2. SAVE FOR ONLINE: Saves and adds data to existing file and clears the data at the register

Select the operation "SAVE" or "SAVE FOR ONLINE" and press the TL/NS key; the following data list window is displayed. (If you selected "SAVE FOR ONLINE", only "EJ DATA" is displayed.)

Text	Data list
SALES DATA	Sales data (CSV format)
EJ DATA	Electronic journal data
IND. PROGRAM	Select the individual programming data: DEPARTMENT, PLU/EAN GRAPHIC LOGO LOGO TEXT TAX
ALL PROGRAM	All programming data
ALL RAM DATA	All RAM data

(2) Select the data menu from the list and press the TL/NS key, the confirmation window is displayed.

To save the required data file, select OK and press the TL/NS key.

To cancel the operation, select CANCEL and press the TL/NS key.

■ Data loading

The programming data can be loaded from the SD card.

Procedure

(1) Select "2 LOADING" in the SD CARD mode and press the **[TL/NS]** key. The following selection window is displayed.

Text	Data list
IND. PROGRAM	Select the individual programming data: DEPARTMENT, PLU/EAN GRAPHIC LOGO LOGO TEXT TAX
ALL PROGRAM	All programming data
ALL RAM DATA*	All RAM data

(2) Select the data menu from the list and press the **[TL/NS]** key, the confirmation window is displayed.

To load the programming data file, select OK and press the **[TL/NS]** key.

To cancel the operation, select CANCEL and press the **[TL/NS]** key.

* When "ALL RAM DATA" is selected, the register resets the program in the last save point after loading all the RAM data.

NOTE *The loading operation must be circumspect in execution, the sales data and/or all programming data will be recovered with the back-up data.*

12 Electronic Journal

■ Electronic journal

This function is intended to record the journal data in the electronic journal file (memory) instead of journal paper.

• Recording data

The register records the printing output to the journal printer in all modes into the electronic journal file.

• Reporting (X report)

The register reports the journal data (same as normal journal formats) in the electronic journal file by the report printer.

Operation: Select the reading operation "E.JOURNAL" in X1/Z1 or OPXZ (only printing) mode.

It is possible to use filter functions (consecutive no./date/time/clerk code).

C.C. No. (Consecutive no.): ALL or RANGE (designate start no./end no.)

DATE (Date): ALL or RANGE (designate start date/end date)

TIME (Time): ALL or RANGE (designate start time/end time)

CLERK (Clerk code): ALL or INDIVIDUAL (designate clerk code)

• Resetting (Z report)

It is possible to take the resetting report of the journal data in the electronic journal file by the report printer.

Operation: Select the resetting operation "E.JOURNAL" in X1/Z1 or OPXZ mode.

The filter functions (consecutive no./date/time/clerk code) can not be used.

13

European Article Number (EAN) or Universal Product Code (UPC)

■ EAN or UPC code

Your machine can transact the following codes:

- UPC-A (Number system character: 0, 2, 3, 4)
- UPC-E
- EAN-8
- EAN-13
- Internal code EAN-8/EAN-13
- ITF-14

For the codes used in-store marking, there are two types of PLU type (treated as a code like PLU code) and Non-PLU type (price/quantity information is included in the code).

When a code is non-PLU type, the price/quantity in the code is read for sales entry (in case of quantity, "quantity multiplies preset unit price" is processed to obtain price.)

UPC-A

- Number system character: 0 <used in the source marking>
- Number system character: 3 <used as NDC or HRI>

For entry, a full 12 digits number or 11 digits number (omitting the check digits) must be entered.

- Number system character: 2 <In-store marking Non-PLU type>
You can program the format in "EAN NON-PLU" in ARTICLE setting.
- Number system character: 4 <In-store marking PLU type>

For entry, a full 12 digits number, 11 digits number (omitting the check digit), or a leading zero plus 12 digits number must be entered. (Any numbers are allowed for the digits marked with *, and on the receipt/journal, non-PLU type code is printed like 2020008**** (****: price information).)

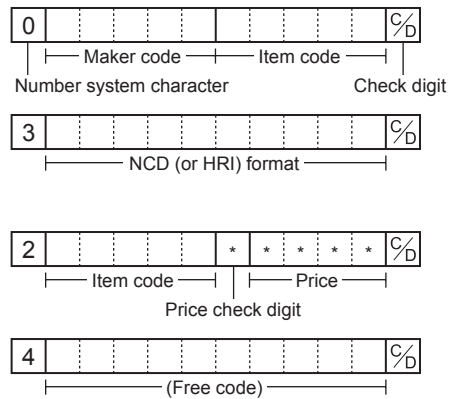

UPC-E

- UPC-E is a zero-suppressed version of UPC-A that conforms to the UPC-E Standards. This code is used for marking small package.

For entry, a 6 digits number or a leading zero plus 6 digits number must be entered.

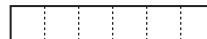

EAN-8

- Ordinary EAN-8 code (flag: neither 0 nor 2) <used in the source marking>

For entry, a full 8 digits number must be entered.

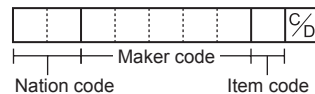

- Internal code (flag 2) <in-store marking non-PLU short type>
Program the format in "EAN NON-PLU" in ARTICLE setting.
- Internal code (flag 0) <in-store marking PLU short type>

For entry, a full 8 digits number must be entered. On the receipt/journal, non-PLU type code is printed like 208**** (****: price/quantity information)

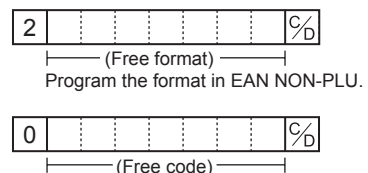

EAN-13

- Ordinary EAN-13 code (used in the source marking)

For entry, you must enter a full of 13 digits number.

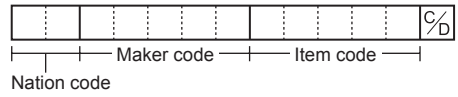

- Internal code (used in the in-store marking, the flag character number: 20 through 29 and 02)
Program the format in "EAN NON-PLU" in ARTICLE setting.

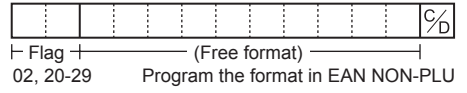

ITF-14

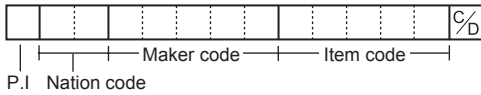

■ Add-on code

UPC-A and EAN-13 may be followed by a two digits number or a five digits number as add-on code, excepting UPC-A without a check digit plus two or five digits add-on code.

Therefore, the total number of digits enterable for sales entries are as shown below:

Code entry	No add-on code	2-digit add-on code	5-digit add-on code
UPC-A	12	14	17
UPC-A w/leading zero	13	15	18
UPC-A w/o check digit	11	–	–
UPC-E	6	–	–
EAN-8	8	–	–
EAN-13	13	15	18

NOTE

Your register does not read automatically the encoded price of the press code and does not store the 2-digit and 5-digit Add-On code.

14 EURO Migration Function

Basically your register can be automatically modified to correspond to the introduction of EURO by executing the operation “EURO STATUS” in X2/Z2 mode. However, there are several options you must set depending on your need. Carefully conduct necessary settings.

EURO status:

You can select status from following 4 types ((A), (B), (C), or (D)). And the selectable type is decided as follows for each status. Type (A) is the base status (initial status).

From type (A) — selectable —> Type (B), (C), or (D)
 From type (B) — selectable —> Type (C), (D)
 From type (C) — selectable —> Type (D)

	Items	Type (B)	Type (C)	Type (D)
1	General Z1 report	ISSUE	ISSUE	ISSUE
2	General Z2 report	ISSUE	ISSUE	ISSUE
3	GT1/2/3 & Training GT	—	CLEAR	CLAER
4	Convert the unit price of DEPT/PLU*	—	CONVERTING	CONVERTING
5	EX1 amount printing for total and change	YES	YES	NO
6	EX1 calculation method	DIVISION	MULTI.	MULTI.
7	EX1 currency symbol	[EURO]	The current domestic currency symbol	—
8	EX1 TAB	2	The current domestic TAB	—
9	Domestic currency symbol	—	[EURO]	[EURO]
10	Domestic TAB	—	2	2
11	Rounding system (Denmark/ Sweden/Normal)	—	Normal	Normal
12	Rounding up/down of the unit digits of amount	—	No	No
13	Lowest digit entering limitation of item	—	Arbitrary	Arbitrary
14	Lowest digit entering limitation of payment	—	Arbitrary	Arbitrary
15	Difference memory	—	No	No
16	Rounding of foreign currency for EX1	ROUND OFF (4DOWN-5UP)	ROUND OFF (4DOWN-5UP)	ROUND OFF (4DOWN-5UP)

The marked items “—” is remaining the current data.

*: The preset rate of the Exchange1 is applied as the conversion rate, and the calculation method is set to “division”. When the conversion has been made, the message “PRICE CONVERTED” is printed on the report.

Setting the date and time when the automatic EURO modification operation should be executed

To certainly execute the automatic modification operation, you can program the scheduled date and time to execute the automatic EURO modification operation. From two days before the preset date, the remaining days are printed at the bottom of the daily full resetting report.

****CID	*173.17
*CH ID	*81.00
CA/CHK ID	*254.17
CHK/CG	*10.18
OVCS REMAIN	*0.00

EURO START	
20/02/2011 1:00	
DAYS TO EURO	<2>

Date and time setting will be reset after the execution of automatic modification operation, and again you can program the date and time for the next automatic modification operation.

Also you can make the automatic EURO modification operation compulsory. When the above-mentioned preset date and time has come, and also when you start an entry in the REG/MGR mode, the error message "EURO CHANGE ENTRY COMPULSORY" will be displayed. You cannot start any operation in the REG/MGR mode until you make the operation.

Automatic EURO modification operation

1. Select "5 X2/Z2 MODE".
2. Select "3 EURO STATUS" from the menu.
3. Select the status you want to set (B, C or D) referring to the table on the previous page. Press the key to toggle the options.

Please note that once you set a status, you cannot return to the previous status(es).

Important note

As for the miscellaneous keys, such as and keys, and for the HALO setting, the automatic conversion will not be made. You need to change the % rates or amounts in the PGM mode after the execution of the automatic modification operation for EURO so that they are based on amounts in EURO.

It is executed some of following operation which is needed for each status.

NOTE

1) Issue General Z1 report. 2) Issue General Z2 report. 3) Clear GT1/2/3 and Training GT. 4) Convert the unit price of departments/PLUs/EANs from LOCAL currency to EURO. If new unit price is over the max digits, its price is set as "0.00". 5) Change PGM function "EX1 amount printing for total and change YES/NO". 6) Change PGM function "EX1 calculation method DIVISION/MULTIPLICATION". 7) Set "EX1 currency symbol" as the suitable data. 8) Set "EX1 TAB" as the suitable data. 9) Set "Domestic currency symbol" as EURO SYMBOL. 10) Set "Domestic TAB" as "2". 11) Set "Rounding SYSTEM (Denmark/Sweden/Normal)" as "Normal". 12) Set "Rounding up/down of the unit digits of AMOUNT" as "No". 13) Set "Lowest digit entering limitation of item" as "Arbitrary". 14) Set "Lowest digit entering limitation of payment" as "Arbitrary". 15) Set "Difference memory" as "No". 16) Set "Rounding of foreign currency for EX" as "Round off(4-DOWN,5-UP)". (EURO Regulation)

NOTE

This job cannot set the following additional EURO function. You must set the following items by each programming after executing the automatic EURO modification operation.

- 1) Exchange1 rate, (2) "Check, Credit operation for Exchange1 — YES/NO"

15 Operator Maintenance

In Case of Power Failure

When power is lost, the register retains its memory contents and all information on sales entries.

- When power failure is encountered in register idle state or during an entry, the register returns to the normal state of operation after power recovery.
- When power failure is encountered during a printing cycle, the register carries out the correct printing procedure after power recovery.

In Case of Printer Error

If the printer runs out of paper, the printer will stall, and “PAPER EMPTY” will appear on the display. Key entries will not be accepted. Referring to “Replacing the Paper Roll” in this chapter, install a new paper roll in the proper position, then press the **CL** key. The printer will print the power failure symbol and resume printing.

If the print roller arm comes up, the printer stalls, and “PAPER EMPTY” will appear on the display. Key entries will not be accepted. Push down the arm until it is securely locked, then press the **CL** key. The printer will print the power failure symbol and resume printing.

Cautions in Handling the Printer and Recording Paper

■ Cautions in handling the printer

- Avoid the following environments:
 - Dusty and humid places
 - Direct sunlight
 - Iron powder (A permanent magnet and electromagnet are used in this machine.)
- Never pull the paper when the print roller arm is locked. First lift up the arm, and then remove the paper.
- Never touch the surface of the print head and print roller.

■ Cautions in handling the recording paper (thermal paper)

- Use only the paper specified by SHARP.
- Do not unpack the thermal paper until you are ready to use it.
- Avoid heat. The paper will color at around 70°C.
- Avoid dusty and humid places for storage. Avoid direct sunlight.
- The printed text on the paper can discolor under the following conditions:
 - Exposure to high humidity and temperature
 - Exposure to the direct sunlight
 - Contact with glue, thinner or a freshly copied blueprint.
 - Heat caused by friction from scratching or other such means.
 - Contact with a rubber eraser or adhesive tape.
- Be very careful when handling the thermal paper. If you want to keep a permanent record, copy the printed text with a photocopier.

Installing Batteries

This register displays a low battery warning message “LOW BATTERY” when the batteries are low, and displays a no battery warning message “NO BATTERY” when batteries are extremely low or batteries are not installed.

If no batteries are installed, install two new alkaline batteries LR6 (“AA” size) at once. If batteries are already installed, replace them with new ones as soon as possible. If the AC power cord is disconnected or a power failure occurs when the batteries are dead or not installed, all the programmed settings will be reset to the default settings and any data stored in memory will be cleared.

NOTE *Improper use of batteries could cause them to burst or leak, which might damage the interior of the register. Please take the following precautions:*

- *Be sure that the positive (+) and negative (-) poles of each battery are oriented properly.*
- *Never mix batteries of different types.*
- *Never mix old batteries and new ones.*
- *Never leave dead batteries in the battery compartment.*
- *Remove the batteries if you plan not to use the register for long periods.*
- *Should a battery leak, clean out the battery compartment immediately, taking care not to let the battery fluid come into direct contact with your skin.*
- *If an incorrect battery is used, it may explode or leak.*
- *For battery disposal, follow the relevant law or regulation in your country.*

Replacement

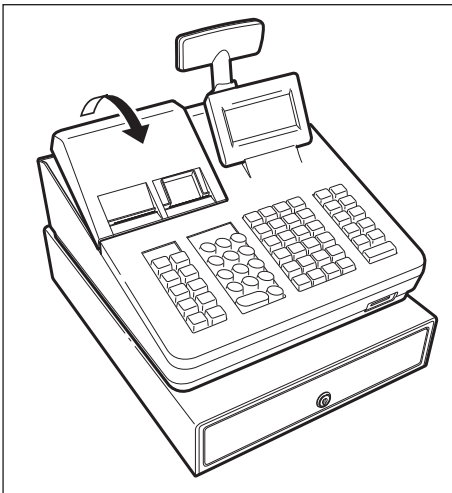

- 1.** Be sure the register is plugged in.
- 2.** Remove the printer cover.

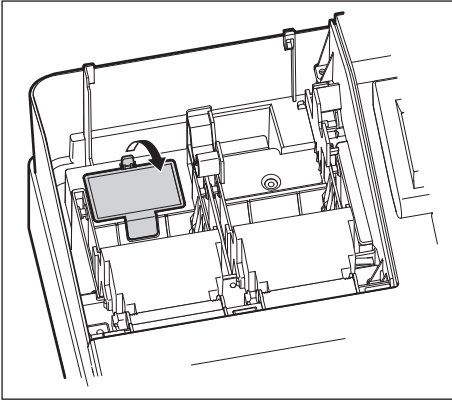

3. Open the battery cover and remove the old batteries.

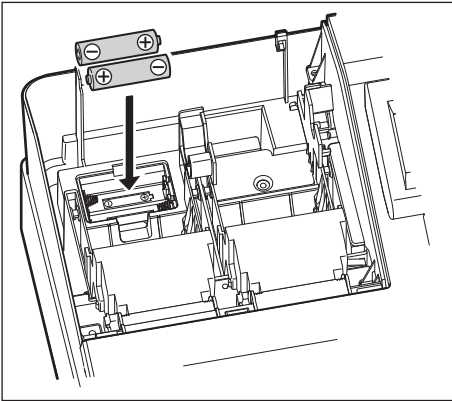

4. Install two new LR6("AA" size) batteries into the battery compartment.

5. Close the battery cover.

6. Replace the printer cover.

Replacing the Paper Roll

■ Recording paper specifications

Be sure to use paper rolls specified by SHARP.

The use of any other paper rolls than specified could cause paper jamming, resulting in register malfunction.

Paper specification

- Paper width: 57.5 ± 0.5 mm
- Max. outside diameter: 80 mm
- Quality: High quality (0.06 to 0.08 mm thickness)

• Be sure to set a paper roll prior to using your machine, otherwise it may cause a malfunction.

Install the paper roll in the printer. Be careful then to set the roll and cut the paper end correctly.

(How to set the paper roll)

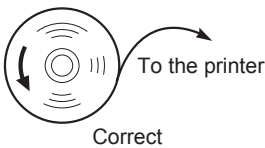
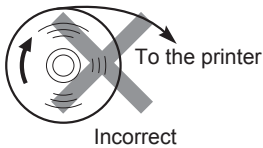

(How to cut the paper end)

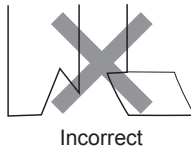

■ Installing Paper Rolls

The register can print receipts and journals. For the printer, you must install the paper rolls (receipt and journal paper rolls) provided with the register.

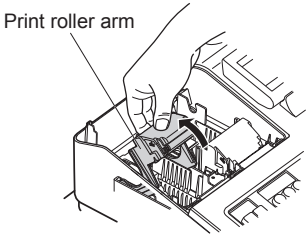

1. Remove the printer cover.
2. Lift up the print roller arm of the receipt side.

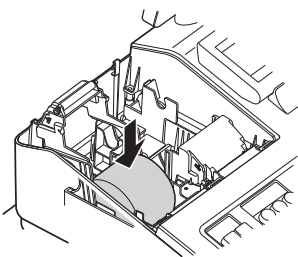

3. Set a paper roll in the paper roll cradle of the receipt side as per the diagram.

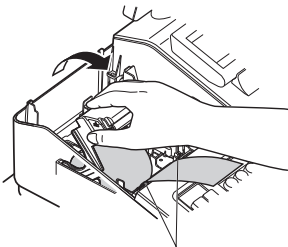

4. Feed the end of the paper along with the paper positioning guides as per the diagram.
5. While holding down the paper, slowly close the print roller arm of the receipt side, and push down the arm until you hear a click locking the arm.

NOTE If the print roller arm is not securely locked, printing is not done right. If this problem occurs, open the arm, and close the arm instructed above.

6. Cut off the excess paper.

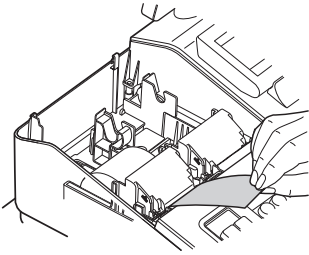

Print roller arm

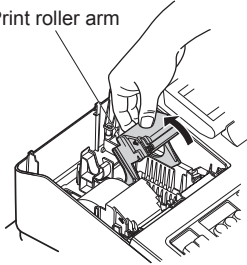

7. Lift up the print roller arm of the journal side.

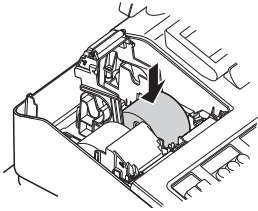

8. Set a paper roll in the paper roll cradle of the journal side as per the diagram.

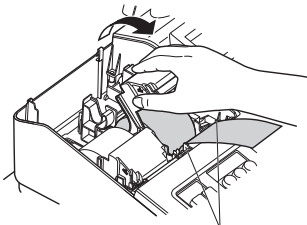
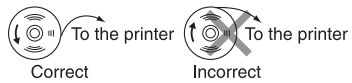

9. While holding down the paper, slowly close the print roller arm of the journal side, and push down the arm until you hear a click locking the arm.

Paper positioning guides

Paper holding plate

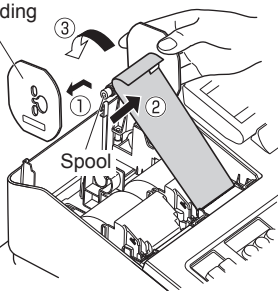

10. ① Remove the paper holding plate from the spool.
② Insert the end of the paper into the slit in the spool. (Press the journal paper feed key to feed more paper if required.)
③ Wind the paper two or three turns around the spool shaft.

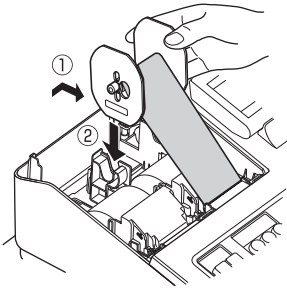

11. ① Mount the paper holding plate onto the take-up spool.
- ② Set the spool on the bearing, and press the journal paper feed key to take up excess slack in the paper.

12. Replace the printer cover.
13. Press the receipt paper feed key to make sure the paper end comes out of the printer cover and clean paper appears.

NOTE

If the paper end does not come out, open the printer cover, and pass the paper end between the paper cutter and the paper guide of the printer cover, and replace the printer cover.

■ Replacing the paper roll

When colored dye appears on the edges of the paper roll, it is time to replace the paper roll. Use paper of 57.5 ± 0.5 mm in width. To prevent jamming be sure to use paper specified by SHARP.

Replacing the receipt paper roll:

1. Confirm that the REG mode has been selected.
2. Remove the printer cover.
3. Lift up the print roller arm of the receipt side.
4. Remove the paper roll from the paper roll cradle of the receipt side.

NOTE *Do not pull the paper through the printer.*

5. Install a new paper roll correctly by following the steps in "Installing Paper Rolls".

Replacing the journal paper roll:

1. Confirm that the REG mode has been selected.
2. Remove the printer cover.
3. Press the journal paper feed key to advance the journal paper until its printed part is out of the way.
4. Cut the paper and remove the take-up spool from the bearing.

NOTE *Do not pull the paper through the printer.*

5. Lift up the print roller arm of the journal side.
6. Remove the paper roll from the paper roll cradle of the journal side.
7. Remove the paper holding plate of the take-up spool.
8. Remove the printed journal roll from the take-up spool.
9. Install a new paper roll correctly by following the steps in "Installing Paper Rolls".

■ Removing a Paper Jam

CAUTION: The paper cutter is mounted on the printer cover. Be careful not to cut yourself. Never touch the printer head immediately after printing, as the head may still be hot.

1. Remove the printer cover.
2. Lift up the print roller arm.
3. Remove the paper jam. Check for and remove any shreds of paper that may remain in the printer.
4. Reset the paper roll correctly by following the steps in "Installing Paper Rolls".

Cleaning the Printer (Printer Head/Sensor/Roller)

When the printed text is getting dark or faint, paper dust may be stuck to the printer head, sensor and/or roller. Clean them as follows:

CAUTION: Never touch the printer head with a tool or anything hard as it may damage the head.
The paper cutter is mounted on the printer cover. Be careful not to cut yourself.

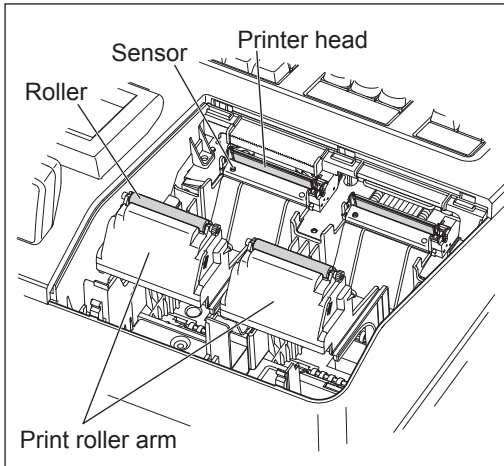

1. Select the OFF mode.
2. Remove the printer cover.
3. Lift up the print roller arm.
4. Remove the paper roll referring to the "Removing the paper roll" section.
5. Clean the printer head with a cotton swab or soft rag moistened with ethyl alcohol or isopropyl alcohol. Clean the roller and the sensor in the same manner.
6. Reset the paper roll correctly by following the steps in "Installing the paper roll."

Removing the Till and the Drawer

The till in the register is detachable. After closing your business for the day, remove the till from the drawer and keep the drawer open. The coin case is also detachable from the till. To detach the drawer, pull it forward fully with the till removed, and remove it by lifting it up.

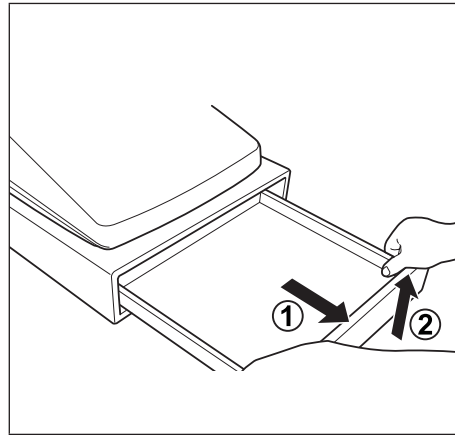
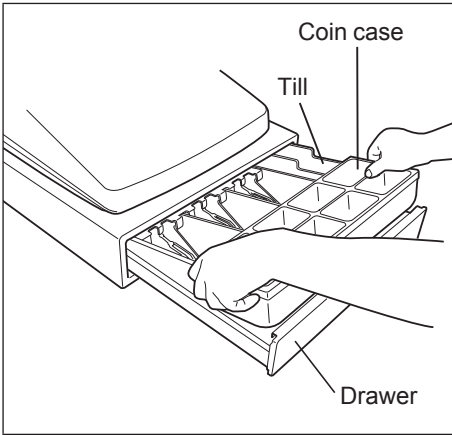

Opening the Drawer by Hand

The drawer automatically opens in the usual way. However, when power failure is encountered or the machine becomes out of order, slide the lever located on the bottom of the machine in the direction of the arrow. (See the figure below.) The drawer will not open, if it is locked with a drawer lock key.

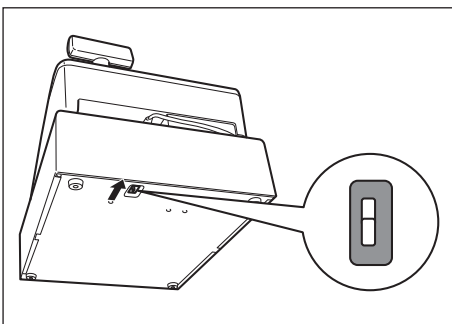

Drawer Lock Key

This key locks and unlocks the drawer.
To lock it, turn 90 degrees counterclockwise.
To unlock it, turn 90 degrees clockwise.

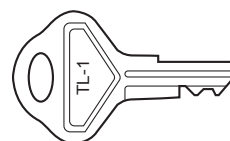

Installing the Fixing Angle Bracket

To prevent the register from moving when the drawer opens, the fixing angle bracket is supplied with the register. By attaching the bracket to the table where the register is installed, you can hook the register on this bracket and secure the register to its position.

How to install the fixing angle bracket

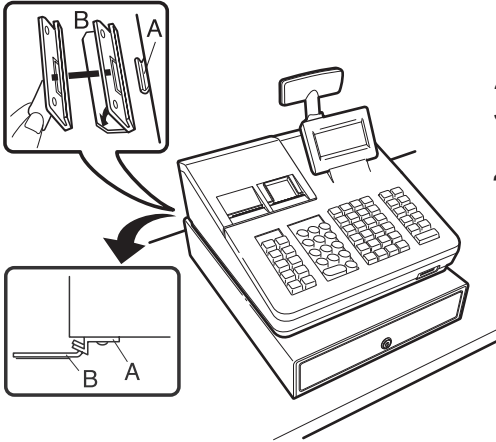

1. Thoroughly clean the location where the fixing angle bracket (B) is to be placed.
2. Peel off the adhesive tape on the fixing angle bracket.
3. Hook the angle bracket onto the hook (A) that is located at the bottom rear of the register.
4. Firmly stick the fixing angle bracket to the table surface that you cleaned above.

How to remove the register from the fixing angle bracket

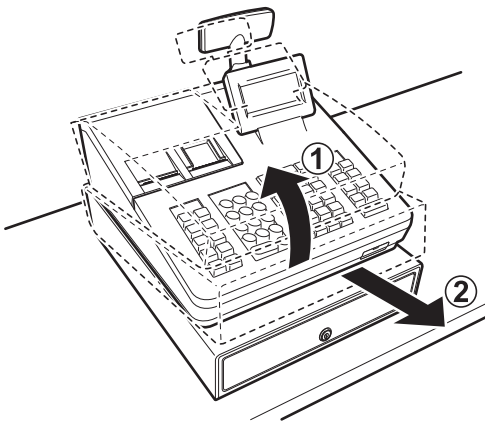

1. Lift up the front of the register and pull the register towards you.

Before Calling for Service

If you encounter any of the following problems, please read below before calling for service.

Fault	Checking
• The display does not illuminate.	• Is power supplied to the electric outlet? • Is the power cord plug out or loosely connected to the electric outlet? • Is the register in screen-save mode?
• The display is illuminated, but the whole machine refuses entries.	• Is a clerk code assigned to the register? • Is the register in the REG mode?
• No receipt is issued.	• Is the receipt paper roll properly installed? • Is there a paper jam? • Is the receipt function in the "OFF" status? • Is the print roller arm securely locked?
• No journal paper is taken up.	• Is the take-up spool installed on the bearing properly? • Is there a paper jam?
• Printing is unusual.	• Are the printer head/sensor/roller clean? • Is the paper roll properly installed?

16 Specifications

Model:	XE-A307	
Dimensions:	360 (W) x 425 (D) x 330 (H) mm	
Weight:	Approx. 12.0 kg	
Power Source:	Official (nominal) voltage and frequency	
Power Consumption:	Stand-by: 9.8 W (When the official voltage is 220 to 230 V, 50 Hz/60 Hz) 9.3 W (When the official voltage is 230 to 240 V, 50 Hz) Operating: 37.8 W (max.) (When the official voltage is 220 to 230 V, 50 Hz/60 Hz) 35.1 W (max.) (When the official voltage is 230 to 240 V, 50 Hz)	
Working Temperature:	0 to 40 °C (32 to 104 °F)	
Humidity:	20 % to 90 %	
Display:	Operator display:	LCD display with Tilt mechanism 160 (W) x 64 (H) (dots)
	Customer display:	7-segment LED display
Printer:	Type:	Two-station thermal printer
	Printing speed:	Approx. 12 lines/second
	Printing capacity:	30 digits each for receipt/journal paper
	Other functions:	<ul style="list-style-type: none"> - Receipt (ON-OFF) function - Compression print for the journal and electronic journal - Receipt and journal independent paper feed function
Logo:	Graphic logo printing:	
	Size:	130 (H) x 360 (W) pixel Area of black must be less than 35% of all area.
	Logo message printing:	
	Logo message for the receipt (max. 30 characters x 6 lines)	
Paper Roll:	Width: 57.5 ± 0.5 mm	
	Max. diameter: 80 mm	
	Quality: High quality (0.06 to 0.08 mm thickness)	
Cash Drawer:	5 slots for bills and 8 for coin denominations	
Accessories:	Basic User Manual:	1 copy
	Paper roll:	2
	Take-up spool	1
	Paper holding plate	1
	Drawer lock key	2
	Fixing angle bracket	1
	Battery caution label	1

*Specifications and appearance are subject to change without notice for improvement.

Warning

This is a Class A product. In a domestic environment this product may cause radio interference in which case the user may be required to take adequate measures.

Achtung

Dies ist ein Gerät der Klasse A. Dieses Gerät kann im Wohnbereich Funkstörungen verursachen; in diesem Fall kann vom Betreiber verlangt werden, angemessene Gegenmaßnahmen durchzuführen und dafür aufzukommen.

Advertencia

Este es un producto de la clase A. En un ambiente doméstico es posible que este producto cause radiointerferencia. En este caso se solicita al usuario que tome medidas adecuadas.

Advertência

Este é um produto de classe A. Num ambiente doméstico este produto pode causar interferência rádio sendo que neste caso o utilizador terá que tomar medidas adequadas.

Avertissement

Ceci est un produit de Classe A. Dans un environnement domestique ce produit risque de provoquer une interférence radio, auquel cas l'utilisateur sera obligé d'observer les mesures adéquates.

Waarschuwing

Dit is een Klasse A-product. Het is mogelijk dat dit product in de huiselijke omgeving radiostoringen veroorzaakt waartegen de gebruiker afdoende maatregelen dient te nemen.

Avvertenza

Questo è un prodotto di Classe A. In un ambiente domestico questo prodotto può causare interferenze radio, nel qual caso l'utilizzatore può essere tenuto a prendere provvedimenti adeguati.

Advarsel

Dette er et klasse A produkt. I et hjemligt miljø kan produktet forårsage radio forstyrrelser, hvor brugeren kan være forpligtet til at træffe passende foranstaltninger.

Advarsel

Dette er et klasse A produkt. Innendørs kan dette produktet skape radioforstyrrelser. I så tilfelle må brukeren iverksette nødvendige tiltak.

Varoitus

Tämä on luokan A tuote. Kotiympäristössä tämä tuote saattaa aiheuttaa radiohäiriötä, jossa tapauksessa käyttäjän on ehkä ryhdyttävä tarvittaviin toimenpiteisiin.

Varning

Detta är en produkt av klass A. I hemmiljö kan produkten störa radiomottagning, i vilket fall användaren kan behöva vidta motåtgärder.

Varování

Toto je výrobek třídy A. Je-li výrobek provozován v domácím prostředí, může způsobovat radiové rušení jiných zařízení a uživatel proto musí provést odpovídající opatření.

Upozoreenje

Ovo je proizvod A klase. U domaćem okruženju ovaj proizvod može prouzročiti radio smetnje što može zahtijevati od korisnika da poduzme odgovarajuće mjere.

Varovanie

To je proizvod razreda A. V domaćem okolju lahko ta izdelek povzroči radijske motnje. V tem primeru mora uporabnik ustrezno ukrepati.

Hoiatus

Tegemist on A-klassi tootega. Kodukeskkonnas kasutamisel võib antud toode põhjustada raadiointerferentsi, mis omakorda nõuab kasutajalt sobivate meetmete rakendamist.

Προειδοποίηση

Αυτό είναι ένα προϊόν κατηγορίας Α. Σε ένα εσωτερικό περιβάλλον αυτό το προϊόν μπορεί να προκαλέσει τη ράδιο ακτινοβολία. Σε αυτή την περίπτωση ο χρήστης πρέπει να λάβει επαρκή μέτρα προστασίας.

Uwaga

Urządzenie to jest urządzeniem klasy A. W środowisku mieszkalnym może ono powodować zakłócenia radioelektryczne. W takich przypadkach można żądać od użytkownika zastosowania odpowiednich środków zaradczych.

Upozoreenje

Ovo je proizvod klase A. U kućnom okruženju ovaj proizvod može prouzrokovati radio smetnje, u tom slučaju od korisnika se zahteva da preduzme odgovarajuće mere.

FOR CUSTOMERS IN U.K.

IMPORTANT

The wires in this mains lead are coloured in accordance with the following code:

BLUE:	Neutral
BROWN:	Live

As the colours of the wires in the mains lead of this apparatus may not correspond with the coloured markings identifying the terminals in your plug proceed as follows.

The wire which is coloured BLUE must be connected to the terminal which is marked with the letter N or coloured black.

The wire which is coloured BROWN must be connected to the terminal which is marked with the letter L or coloured red.

The apparatus must be protected by a 3A fuse in the mains plug or distribution board.

CAUTION: DO NOT CONNECT THE LIVE (BROWN) WIRE OR THE NEUTRAL (BLUE) WIRE TO THE EARTH TERMINAL OF YOUR 3-PIN MAINS PLUG.

Shielded interface cables must be used with this equipment to maintain compliance with EMC regulations.

Noise level LpA: 59.6 dB(A-weighted)

Measured according to EN ISO 7779:2001

[Maximum value if the cash drawer springs open LpAI: 78.2 dB(A-weighted)]

SHARP

SHARP ELECTRONICS (Europe) GmbH

SonninstraÙe 3, D-20097 Hamburg

SHARP CORPORATION